



Digitized Automation for a Changing World

Delta Standard Compact Drive MS300 Series



www.deltaww.com

Send Quote Requests to info@automatedpt.com
Call +1(800)985-6929 to talk to an expert



Compact and Intelligent

The new standard for micro drives

The automation industry today continues to face challenges such as increasing competition and rising costs. In addition to improving productivity and reducing labor, the driving force for automation is the shift to higher efficiency, optimal quality, and most importantly, flexibility and compatibility for a wide range of applications.

Delta's MS300 series are the new generation high performance and standard compact vector control drives that inherit Delta's superior drive technology—all in a compact drive that has been reduced 40% in size.

A variety of essential functions are built-in as standard, including: PLC capacity for simple programming needs, communication slots for various communication cards, and a USB port to make data uploads and downloads fast and easy. This saves the need for additional hardware, while providing more installation space for the power cabinet. Other key features include: Support for both IM and PM motor control for application flexibility, an STO function to ensure worry-free operation while protecting facilities from damage, and a simplified wiring process with a new screwless wiring design of terminal blocks for quick installation.

Saving space, reducing setup and wiring time, and providing high efficiency and a highly stable system, the MS300 micro drives are your key to improving market competitiveness and ensuring success.





Models Overview

- Standard Models
- High Speed Models
- Exterior Design and Interfaces
- Optional Cards

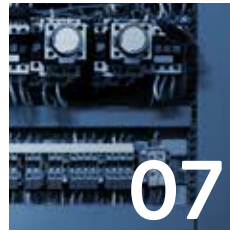

Optimized Space Utilization

- Compact Design
- Side-by-Side Installation



Outstanding Drive Performance

- Supports IM and PM Motors
- High Starting Torque
- Deceleration Energy Backup (DEB)
- Enhanced Braking Capability



Strong System Support

- Multi-motor Control
- Pulse Control
- Built-in PLC
- High Speed Applications
- 24 V_{DC} External Power
- High Overload Capability
- Built-in Brake Chopper
- Versatile Communications



Stable, Safe and Reliable

- Safety Standards
- Enhanced Conformal Coating
- IP40 Models
- Built-in EMC Filter



Easy to Install

- Application Groups
- Built-in USB Port
- Screwless Wiring of Control Terminal



Wide Range of Applications

- Machine Tools
- Woodworking Machines
- Automatic Tool Changers (ATC)
- Pumps
- Packaging Machines
- Textile Machines



Specifications

- Product Specifications
- Wiring
- Dimensions
- Accessories
- Model Name Explanation
- Ordering Information

Models Overview



Standard Models (IP20 /IP40)

115V Single-phase

Applicable Motor Output (kW)	0.2	0.4	0.75
Applicable Motor Output (HP)	0.25	0.5	1
Frame Size	A		C

230V Single-phase

Applicable Motor Output (kW)	0.2	0.4	0.75	1.5	2.2
Applicable Motor Output (HP)	0.25	0.5	1	2	3
Frame Size	A		B	C	

230V Single-phase - with EMC filter

Applicable Motor Output (kW)	0.2	0.4	0.75	1.5	2.2
Applicable Motor Output (HP)	0.25	0.5	1	2	3
Frame Size	B			C	

230V 3-phase

Applicable Motor Output (kW)	0.2	0.4	0.75	1.5	2.2	3.7/4	5.5	7.5	11	15
Applicable Motor Output (HP)	0.25	0.5	1	2	3	5	7.5	10	15	20
Frame Size	A			B	C		D	E		F

460V 3-phase

Applicable Motor Output (kW)	0.4	0.75	1.5	2.2	3.7/4	5.5	7.5	11	15	18.5	22
Applicable Motor Output (HP)	0.5	1	2	3	5	7.5	10	15	20	25	30
Frame Size	A		B	C		D		E		F	

460V 3-phase - with EMC filter

Applicable Motor Output (kW)	0.4	0.75	1.5	2.2	3.7/4	5.5	7.5	11	15	18.5	22
Applicable Motor Output (HP)	0.5	1	2	3	5	7.5	10	15	20	25	30
Frame Size	B			C		D		E		F	

575V 3-phase

Applicable Motor Output (kW)	0.75	1.5	2.2	3.7	5.5	7.5
Applicable Motor Output (HP)	1	2	3	5	7.5	10
Frame Size	A	B	C	C	D	D

Standard Models (IP66)

230V Single-phase

Applicable Motor Output (kW)	0.4	0.75	1.5	2.2
Applicable Motor Output (HP)	0.5	1	2	3
Frame Size	A			B

230V Single-phase - with EMC filter

Applicable Motor Output (kW)	0.4	0.75	1.5	2.2
Applicable Motor Output (HP)	0.5	1	2	3
Frame Size	A		B	

Standard Models (IP66)

230V 3-phase

Applicable Motor Output (kW)	0.4	0.75	1.5	2.2	3.7/4	5.5
Applicable Motor Output (HP)	0.5	1	2	3	5	7.5
Frame Size	A			B		C

460V 3-phase

Applicable Motor Output (kW)	0.4	0.75	1.5	2.2	3.7/4	5.5	7.5
Applicable Motor Output (HP)	0.5	1	2	3	5	7.5	10
Frame Size	A				B	C	

460V 3-phase - with EMC filter

Applicable Motor Output (kW)	0.4	0.75	1.5	2.2	3.7/4	5.5	7.5
Applicable Motor Output (HP)	0.5	1	2	3	5	7.5	10
Frame Size	A			B		C	

Flat Models

460V 3-phase

Applicable Motor Output (kW)	0.75	1.5	2.2	3	3.7
Applicable Motor Output (HP)	1	2	3	4	5
Frame Size	A	B	C		

High-speed Models (IP20/IP40)

230V Single-phase

Applicable Motor Output (kW)	1.5	2.2
Applicable Motor Output (HP)	2	3
Frame Size	C	

230V Single Phase - with EMC filter

Applicable Motor Output (kW)	1.5	2.2
Applicable Motor Output (HP)	2	3
Frame Size	C	

230V 3-phase

Applicable Motor Output (kW)	1.5	2.2	3.7/4	5.5	7.5	11	15
Applicable Motor Output (HP)	2	3	5	7.5	10	15	20
Frame Size	B	C		D	E		F

460V 3-phase

Applicable Motor Output (kW)	1.5	2.2	3.7/4	5.5	7.5	11	15	18.5	22
Applicable Motor Output (HP)	2	3	5	7.5	10	15	20	25	30
Frame Size	B	C		D		E		F	

460V 3-phase - with EMC filter

Applicable Motor Output (kW)	1.5	2.2	3.7/4	5.5	7.5	11	15	18.5	22
Applicable Motor Output (HP)	2	3	5	7.5	10	15	20	25	30
Frame Size	B	C		D		E		F	

Hardware Design

Compact design and user-friendly interface

Removable Keypad

Press to remove; supports remote operation away from drive



5 digits 7 segments LED display, frequency knob, Up and Left/Down function keys

Removable RFI Jumper

Applicable for different application needs



Built-in USB Port

Easy and fast programming setting, update and real-time monitoring and tuning



Screwless Top Cover Design

Press on both side tabs to remove the cover



Removable Fan

Easy to replace and maintain for a longer lifetime



Option Cards

A wide selection of option cards for highly flexible applications



External Power Supply Card (DC 24V)

EMM-BPS02



Communication Cards

EtherCAT
CMM-EC02



EtherCAT **NEW**
CMM-EC03



PROFIBUS DP
CMM-PD02



PROFINET **NEW**
CMM-PN02



EtherNet/IP & Modbus TCP
CMM-EIP02



EtherNet/IP & Modbus TCP
CMM-EIP03



DeviceNet
CMM-DN02



CANopen
CMM-COP02



Built-in 1 Option Slot



Optimized Space Utilization

Compact Design

Provides more powerful features in smaller sizes with reduction up to 40% that effectively optimizes the installation space



Side-by-Side Installation

Supports side-by-side installation with operating temperatures of $-20^{\circ}\text{C} \sim 40^{\circ}\text{C}$; enables highly flexible and highly efficient installation



Outstanding Drive Performance



Supports IM and PM Motors

Supports 4 independent induction motor control parameter sets

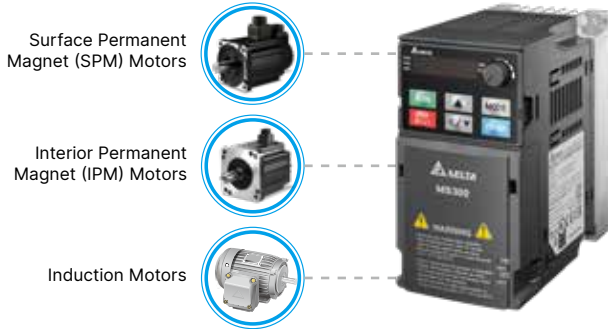

Delta PMA Synchronous Reluctance Motor MSI Series

Can be used with Delta PMA Synchronous Reluctance Motor MSI Series to achieve IE5 high-efficiency energy-saving system solution

Note: For detailed description of motor series products, please refer to Delta's official website.



Enhanced Braking Capability

Provides Deceleration Energy Control Mode to shorten braking time by adjusting the motor speed and current, replacing break resistors

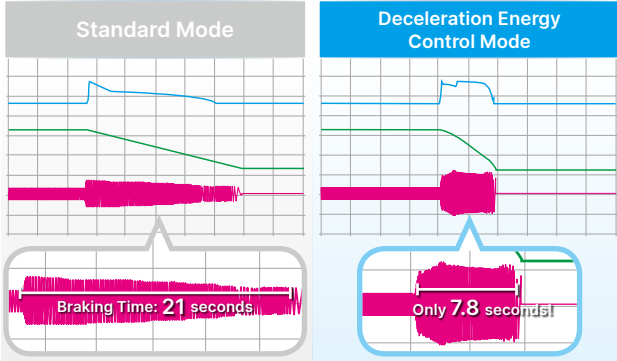

* Actual deceleration performance varies upon different system loads

High Starting Torque

Delivers 200% high starting torque with a low speed control of 0.5Hz and provides outstanding machine stability; suitable for dynamic loading applications

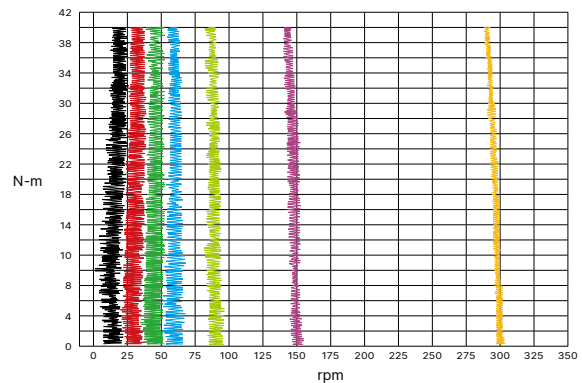

Deceleration Energy Backup (DEB)

Controls the motor deceleration to a stop when an unexpected power shut-down occurs to prevent mechanical damage. When power resumes, the motor will accelerate to its previous speed

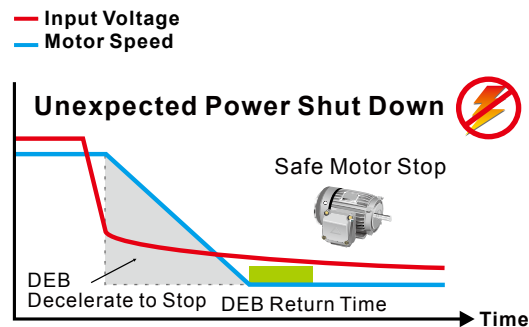
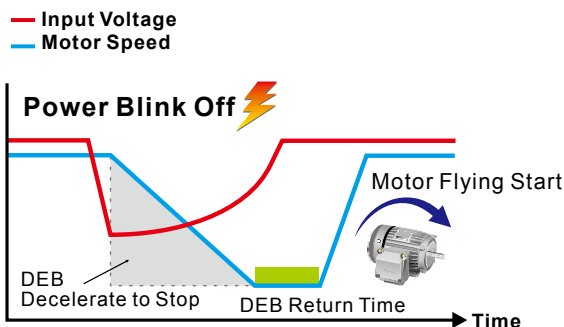

Strong System Support

Multi-motor Control

Supports 4 induction motors switching control

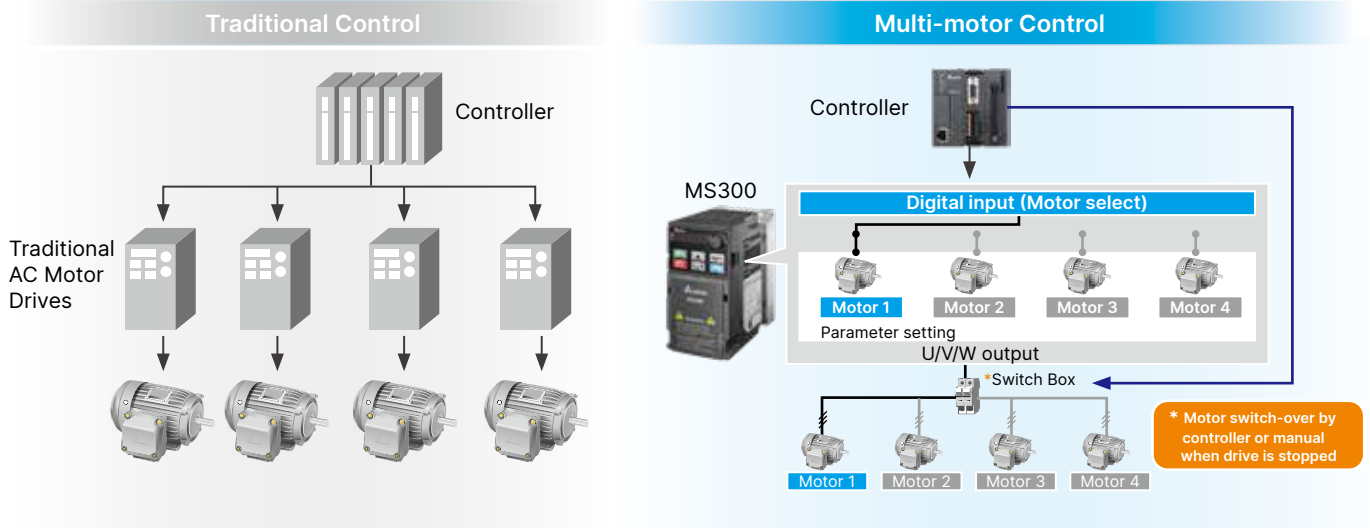

Pulse Input

Supports single pulse input signal from controller as frequency command

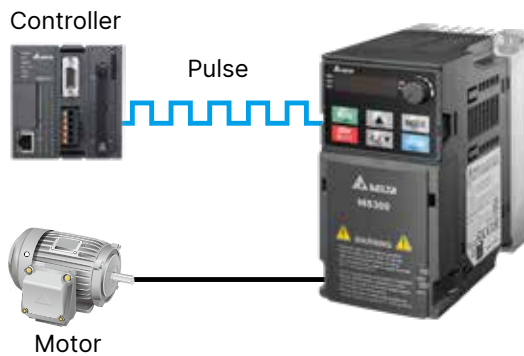

Built-in EMC Filter

Built-in Class A (C2) standard EMC filter; saves on additional procurement cost and wiring time, and provides more cabinet space for other devices to use

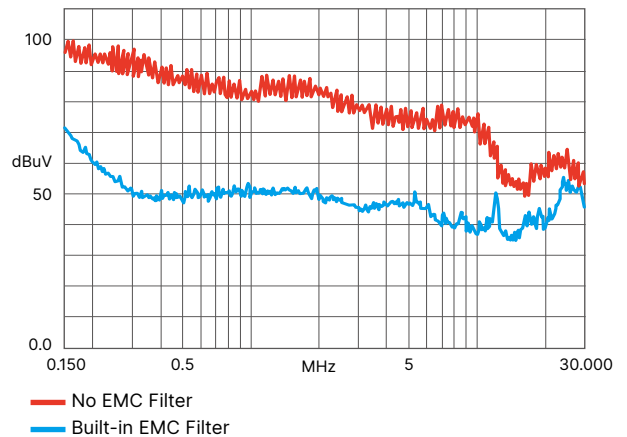

Built-in PLC

Built-in PLC capacity (2k steps) to provide distributed control and independent operation via network connection

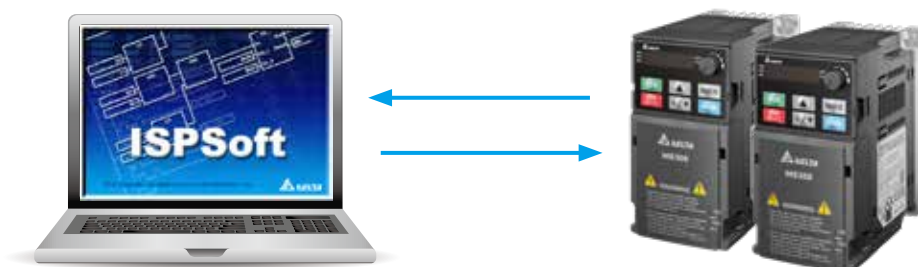

High-Speed Applications

High-speed models are available to support high-speed processing

Type	Model	Frequency Setting
Standard	VFD □□□MS□□□□SAA	0 ~ 599Hz
High-speed	VFD □□□MS□□□□SHA	0 ~ 1500Hz

DC 24V External Power

External power supply card is available for external power connection to protect the system and ensure uninterrupted communication when mains power failure occurs

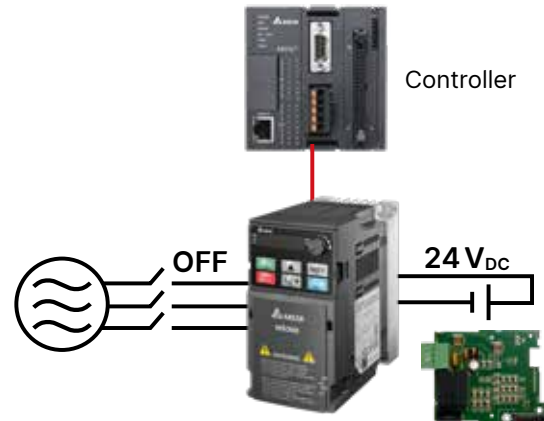

High Overload Capability

- Normal duty: rated current 120% for 60 seconds; 150% for 3 seconds
- Heavy duty: rated current 150% for 60 seconds; 200% for 3 seconds

Built-in Braking Chopper

Larger braking torque capability is provided by using an additional braking resistor

Versatile Communication Interfaces

Built-in RS-485 (Modbus) and various communication card options

Communication	MS300
Modbus	Built-in
PROFIBUS DP	Optional
DeviceNet	Optional
Modbus TCP	Optional
EtherNet/IP	Optional
CANopen	Optional
EtherCAT	Optional
PROFINET	Optional

Stable, Safe and Reliable



Safety Standard

Integrated Safe Torque Off (STO), compliance with:

- ▶ ISO 13849-1:2015 Category 3 PL d
- ▶ EN 60204-1 Category 0
- ▶ EN 61508 SIL2
- ▶ EN 62061 SIL CL 2

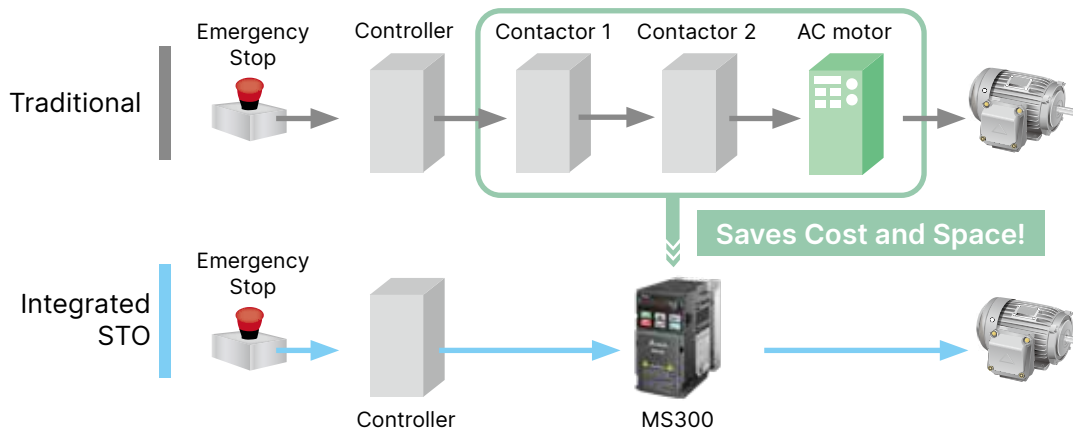

PCB Coating

100% PCB coating (IEC 60721-3-3 class 3C2 standard) ensures drive operation stability and safety in critical environments

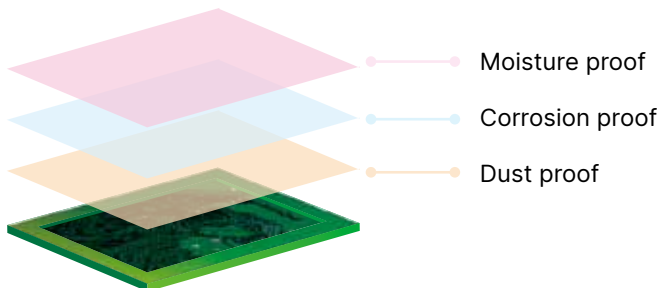

IP40 Models

Strengthened fan coating and concealed air vent prevent dust and other particles from entering the drive, suitable for critical environment applications



IP66 Models

IIP66/NEMA4X water-proof and dust-proof design enables stable operation under harsh environment. Quick installation without control cabinet saves cost



Easy to Install

Application Groups (Macro)

Simplifies the parameter setting process by grouping the parameters for different applications to use

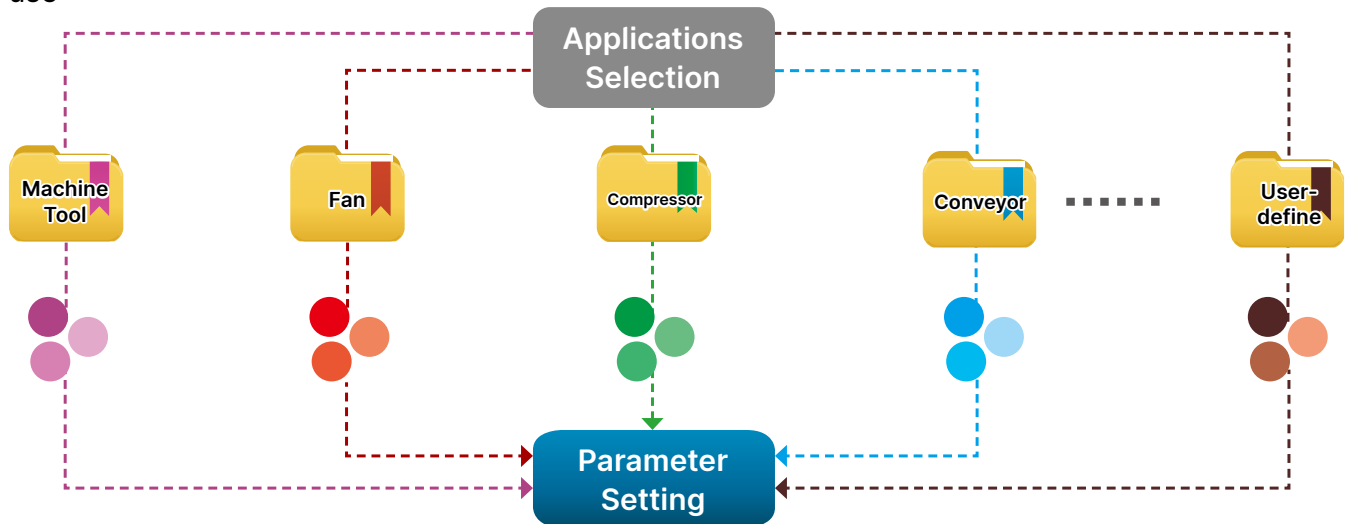

Built-in USB Port

Built-in USB port facilitates the drive setting, updating, real-time monitoring and system tuning process

- No need of USB or RS-485 connectors
- Supports offline (drive power off) parameter setting/copying and system update

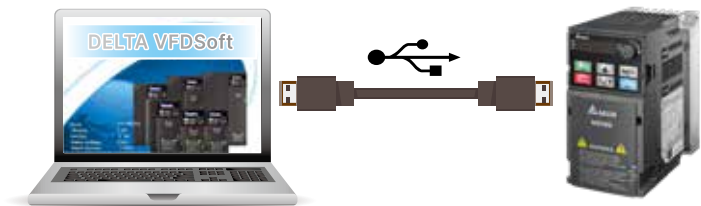

Screwless Wiring of Control Terminal

Spring clamp terminal blocks provide fast and easy wiring

No special tools needed, time-saving

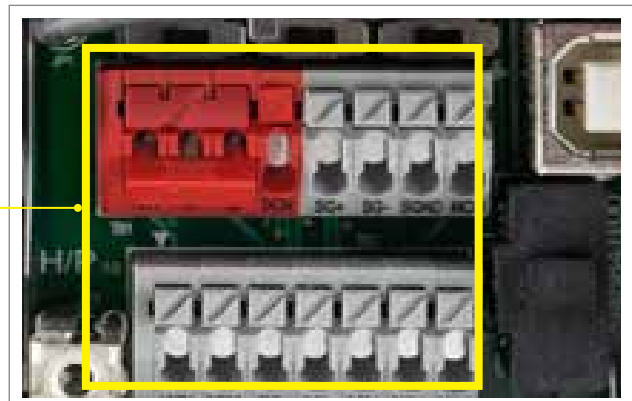

Wide Range of Applications



Machine Tools

Features and Benefits

- High-speed models support main spindle 1500Hz frequency output; suitable for complex and high precision processing applications
- Timely acceleration/deceleration control to improve machinery operation efficiency
- Built-in brake chopper to save on purchasing cost
- Built-in PLC capacity for flexible application needs
- Built-in STO function ensures operator safety and effectively reduces accident risk
- Provides deceleration-to-stop function to protect tools from damage and ensure operator safety

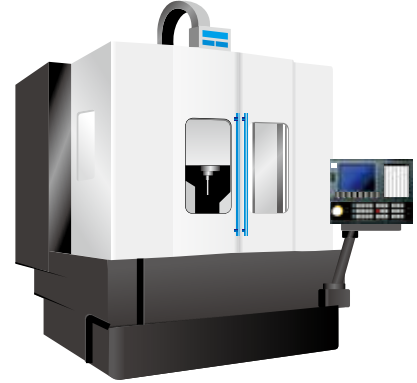

Woodworking Machines

Features and Benefits

- Timely acceleration/deceleration control improves machinery operation efficiency
- Built-in STO function ensures operator safety and effectively reduces accident risk
- Built-in PLC capacity saves on purchasing cost
- Built-in EMC filter effectively reduces electromagnetic interference
- Compact in size and weight, easy to install and maintain

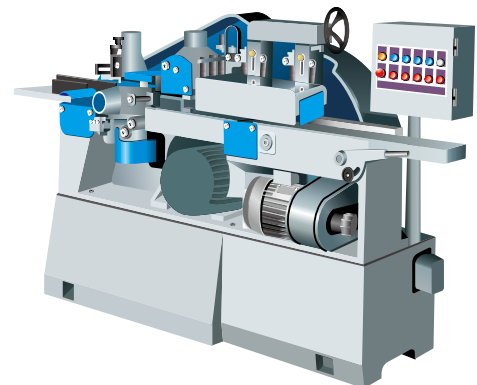

Automatic Tool Changers (ATC)

Features and Benefits

- Compact design of drive provides more cabinet space for other devices to use
- Quick start and timely acceleration/deceleration control function effectively shortens tool changing time and improves system efficiency and productivity
- Simple structure is easy to install and maintain
- Built-in STO function ensures operator safety and effectively reduces accident risk
- Built-in brake chopper saves on purchasing cost

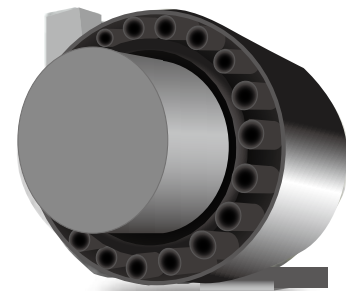

Pump Applications

Features and Benefits

- Built-in PID feedback control
- Built-in PLC capacity saves on purchasing cost of PLC and simpler wiring
- Supports a wide range of input voltages, suitable for various types of pumps application and use in different countries
- Deceleration energy control mode shortens deceleration time and reduces cost and installation space for braking resistor

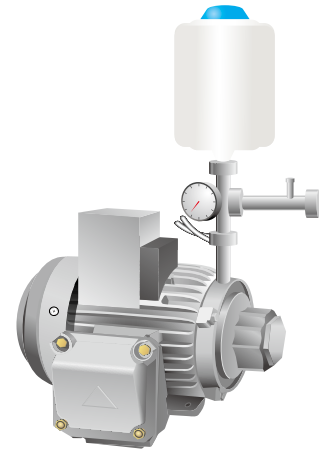

Packaging Machines

Features and Benefits

- Compact design to save installation space
- Built-in STO function ensures operator safety and effectively reduces accident rate
- Built-in brake chopper saves on system construction cost
- Built-in RS-485 (Modbus) and various communication cards upon selection (optional)
- High-speed pulse input
- Supports frequency command by pulse input to improve control precision



Textile Machines

Features and Benefits

- Optimized structural layout and hardware anti-pollution design enhance the frequency converter's environmental tolerance in dust, cotton fluff, and high temperatures (providing IP40 models and flat panel models)
- Improved heatsink design prevents fiber clogging the airway; modular design of fan is easy to clean and provides longer lifetime
- Plate-mount design, allowing customers to design their own cooling systems, with flexible installation and no need to worry about fluff clogging the cooling fan
- Improved braking capability shortens the deceleration-to-stop time and is suitable for sudden stop requirements
- Built-in STO function ensures operator safety and effectively reduces accident rate
- Supports both induction motors and PM motors
- Provides deceleration-to-stop function to protect the equipment from damage when sudden power failure occurs

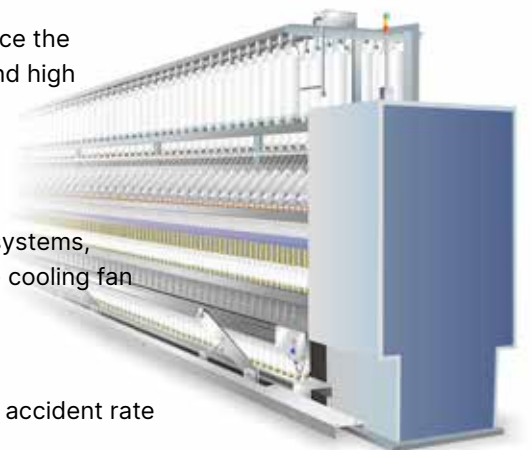

Specifications

IP20/IP40 Models

Single-phase 115 V (Models w/o Built-in EMC Filter)					
Frame			A		C
Applicable Motor Output (kW)			0.2	0.4	0.75
Applicable Motor Output (HP)			1/4	1/2	1
Inverter Output	Heavy Duty	Rated Output Current (A)	1.6	2.5	4.8
	Normal Duty	Rated Output Current (A)	1.8	2.7	5.5
Input	Rated Voltage/Frequency		1-phase AC 100 V ~120 V (-15% ~ +10%), 50/60 Hz		
	Mains Input Voltage Range		85 ~ 132 V		
	Mains Frequency Range		47 ~ 63 Hz		
Carrier Frequency (kHz)			2~15 (default 4)		
Brake Chopper			Built-in		
DC Reactor			Optional		
AC Reactor			Optional		
Cooling Method			Natural air cooling		Fan cooling
Size: W x H (mm)			68 × 128		87 × 157
Size: D (mm)			96	125	152

Single-phase 230 V (Models with Built-in EMC Filter)							
Frame			B		C		
Applicable Motor Output (kW)			0.2	0.4	0.75	1.5	2.2
Applicable Motor Output (HP)			1/4	1/2	1	2	3
Inverter Output	Heavy Duty	Rated Output Current (A)	1.6	2.8	4.8	7.5	11
	Normal Duty	Rated Output Current (A)	1.8	3.2	5	8.5	12.5
Input	Rated Voltage/Frequency		1-phase AC 200 V ~240 V (-15% ~ +10%), 50/60 Hz				
	Mains Input Voltage Range		170 ~ 265 V				
	Mains Frequency Range		47 ~ 63 Hz				
Carrier Frequency (kHz)			2~15 (default 4)				
Brake Chopper			Built-in				
DC Reactor			Optional				
AC Reactor			Optional				
Cooling Method			Natural air cooling	Fan cooling			
Size: W x H (mm)			72 × 142			87 × 157	
Size: D (mm)			159			179	

Single-phase 230 V (Models w/o an EMC Filter)					
Frame		A	B	C	
Cooling Method		Natural air cooling		Fan cooling	
Size: W x H (mm)		68 × 128	68 × 128	72 × 142	87 × 157
Size: D (mm)		96	125	143	152

3-phase 230 V (Models w/o Built-in EMC Filter)															
Frame			A			B		C		D		E		F	
Applicable Motor Output (kW)			0.2	0.4	0.75	1.5	2.2	3.7/4	5.5	7.5	11	15			
Applicable Motor Output (HP)			1/4	1/2	1	2	3	5	7.5	10	15	20			
Inverter Output	Heavy Duty	Rated Output Current (A)	1.6	2.8	4.8	7.5	11	17	25	33	49	65			
	Normal Duty	Rated Output Current (A)	1.8	3.2	5	8	12.5	19.5	27	36	51	69			
Input	Rated Voltage/Frequency		3-phase AC 200 V ~ 240 V (-15% ~ +10%), 50/60 Hz												
	Mains Input Voltage Range		170 ~ 265 V												
	Mains Frequency Range		47 ~ 63 Hz												
Carrier Frequency (kHz)			2 ~ 15 (default 4)												
Brake Chopper			Built-in												
DC Reactor			Optional												
AC Reactor			Optional												
Cooling Method			Natural air cooling				Fan cooling								
Size: W x H (mm)			68 × 128			72 × 142	87 × 157	109 × 207	130 × 250	175 × 300					
Size: D (mm)			96	110	143	143	152	154	185		192				

3-phase 460 V (Models with Built-in EMC Filter)													
Frame			B			C		D		E		F	
Applicable Motor Output (kW)			0.4	0.75	1.5	2.2	3.7/4	5.5	7.5	11	15	18.5	22
Applicable Motor Output (HP)			1/2	1	2	3	5	7.5	10	15	20	25	30
Inverter Output	Heavy Duty	Rated Output Current (A)	1.5	2.7	4.2	5.5	9	13	17	25	32	38	45
	Normal Duty	Rated Output Current (A)	1.8	3	4.6	6.5	10.5	15.7	20.5	28	36	41.5	49
Input	Rated Voltage/Frequency		3-phase AC 380 V ~ 480 V (-15% ~ +10%), 50/60 Hz										
	Mains Input Voltage Range		323 ~ 528 V										
	Mains Frequency Range		47 ~ 63 Hz										
Carrier Frequency (kHz)			2 ~ 15 (default 4)										
Brake Chopper			Built-in										
DC Reactor			Optional										
AC Reactor			Optional										
Cooling Method			Fan cooling										
Size: W x H (mm)			72 × 142			87 × 157	109 × 207	130 × 250	175 × 300				
Size: D (mm)			159			179	187	219		244			

3-phase 460 V (Models w/o an EMC Filter)														
Frame			A		B		C		D		E		F	
Cooling Method			Natural air cooling			Fan cooling								
Size: W x H (mm)			68 × 128		72 × 142	87 × 157	109 × 207	130 × 250	175 × 300					
Size: D (mm)			129	143	143	152	154	185		192				

3-phase 575 V (Models w/o an EMC Filter)														
Frame			A		B		C			D				
Applicable Motor Output (kW)			0.75		1.5		2.2		3.7		5.5		7.5	
Applicable Motor Output (HP)			1		2		3		5		7.5		10	
Inverter Output	Heavy Duty	Rated Output Current (A)	1.7		3		4.2		6.6		9.9		12.2	
	Normal Duty	Rated Output Current (A)	2.1		3.6		5		8		11.5		15	
Input	Rated Voltage/Frequency		3-phase AC 500 V ~ 600 V (-15% ~ +10 %), 50/60 Hz											
	Mains Input Voltage Range		425 ~ 660											
	Mains Frequency Range		47 ~ 63											
Carrier Frequency (kHz)			2 ~ 15 (default 4)											
Brake Chopper			Built-in											
DC Reactor			Optional											
AC Reactor			Optional											
Cooling Method			Natural air cooling		Fan cooling									
Size: W x H (mm)			68 × 128		72 × 142		87 × 157			109 × 207				
Size: D (mm)			143		143		152			154				

IP66/NEMA 4X Models

Single-phase 230V										
Frame			A				B			
VFD_-----SAA			2A8MS21_		4A8MS21_		7A5MS21MN	7A5MS21MF	11AMS21_	
			M N	M F	M N	M F			M N	M F
Applicable Motor Output (kW)			0.4		0.75		1.5	1.5	2.2	
Applicable Motor Output (HP)			0.5		1		2	2	3	
Inverter Output	Heavy Duty	Rated Output Current (A)	2.8		4.8		7.5	7.2	11	
		Carrier Frequency (kHz)	2 ~ 15 (default 4)							
	Normal Duty	Rated Output Current (A)	3.2		5		8.5	8.5	12.5	
		Carrier Frequency (kHz)	2 ~ 15 (default 4)							
Input	Heavy Duty	Rated Input Current (A)	7.3		10.8		16.5	16.5	24.2	
	Normal Duty	Rated Input Current (A)	8.3		11.3		18.5	18.5	27.5	
	Rated Voltage/Frequency		1-phase AC 200V ~ 240V, 50/60Hz							
	Operating Voltage (V _{AC})		170 ~ 264 (-15% ~ +10%)							
	Mains Frequency Range (Hz)		47 ~ 63							
Net Weight (kg)			2.25	2.65	2.6	2.9	3.1	3.95	3.5	4.0
Cooling Method			Natural air cooling					Fan cooling		
EMC Filter			Optional	Built-in	Optional	Built-in	Optional	Built-in	Optional	Built-in
Protection Rating			IP66 / NEMA 4X							

3-phase 230V										
Frame			A			B		C		
VFD_-----SAA			2A8MS23MN	4A8MS23MN	7A5MS23MN	11AMS23MN	17AMS23NB	25AMS23MN		
Applicable Motor Output (kW)			0.4	0.75	1.5	2.2	3.7	5.5		
Applicable Motor Output (HP)			0.5	1	2	3	5	7.5		
Inverter Output	Heavy Duty	Rated Output Current (A)	2.8	4.8	7.5	11	17	25		
		Carrier Frequency (kHz)	2 ~ 15 (default 4)							
	Normal Duty	Rated Output Current (A)	3.2	5	8	12.5	19.5	27		
		Carrier Frequency (kHz)	2 ~ 15 (default 4)							
Input	Heavy Duty	Rated Input Current (A)	3.4	5.8	9.0	13.2	20.4	30		
	Normal Duty	Rated Input Current (A)	3.8	6.0	9.6	15	23.4	32.4		
	Rated Voltage/Frequency		3-phase AC 200V ~ 240V, 50/60Hz							
	Operating Voltage (V _{AC})		170 ~ 264 (-15% ~ +10%)							
Mains Frequency Range (Hz)		47 ~ 63								
Net Weight (kg)			2.3	2.45	2.75	3.4	3.5	4.25		
Cooling Method			Natural air cooling				Fan cooling			
EMC Filter			Optional							
Protection Rating			IP66 / NEMA 4X							

3-phase 460 V												
Frame			A						B			
VFD_ _ _ _ _SAA			1A5MS43_ _		2A7MS43_ _		4A2MS43_ _		5A5MS43MN	5A5MS43MF	9A0MS43_ _	
			M N	M F	M N	M F	M N	M F			M N	M F
Applicable Motor Output (kW)			0.4		0.75		1.5		2.2		3.7	
Applicable Motor Output (HP)			0.5		1		2		3		5	
Inverter Output	Heavy Duty	Rated Output Current (A)	1.5		2.7		4.2		5.5		9	
		Carrier Frequency (kHz)	2 ~ 15 (default 4)									
	Normal Duty	Rated Output Current (A)	1.8		3		4.6		6.5		10.5	
		Carrier Frequency (kHz)	2 ~ 15 (default 4)									
Input	Heavy Duty	Rated Input Current (A)	2.1		3.7		5.8		6.1		9.9	
	Normal Duty	Rated Input Current (A)	2.5		4.2		6.4		7.2		11.6	
	Rated Voltage / Frequency		3-phase AC 380V ~ 480V , 50 / 60 Hz									
	Operating Voltage (V _{AC})		323 ~ 528 (-15% ~ +10%)									
	Mains Frequency Range (Hz)		47 ~ 63									
Net Weight (kg)			2.35	2.65	2.6	2.8	2.8	3.1	3.6	3.8	3.45	3.95
Cooling Method			Natural air cooling						Fan cooling			
EMC Filter			Optional	Built-in	Optional	Built-in	Optional	Built-in	Optional	Built-in	Optional	Built-in
Protection Rating			IP66 / NEMA 4X									

3-phase 460 V														
Frame			c											
VFD_ _ _ _ _SAA			13AMS43_ _						17AMS43_ _					
			M N			M F			M N			M F		
Applicable Motor Output (kW)			5.5						7.5					
Applicable Motor Output (HP)			7.5						10					
Inverter Output	Heavy Duty	Rated Output Current (A)	13						17					
		Carrier Frequency (kHz)	2 ~ 15 (default 4)											
	Normal Duty	Rated Output Current (A)	15.7						20.5					
		Carrier Frequency (kHz)	2 ~ 15 (default 4)											
Input	Heavy Duty	Rated Input Current (A)	14.3						18.7					
	Normal Duty	Rated Input Current (A)	17.3						22.3					
	Rated Voltage / Frequency		3-phase AC 380V ~ 480V , 50 / 60 Hz											
	Operating Voltage (V _{AC})		323 ~ 528 (-15% ~ +10%)											
	Mains Frequency Range (Hz)		47 ~ 63											
Net Weight (kg)			4.25			4.95			4.25			5.05		
Cooling Method			Fan cooling											
EMC Filter			Optional			Built-in			Optional			Built-in		
Protection Rating			IP66 / NEMA 4X											

Flat Models

Three Phase 460 V (without built-in EMC filter)							
Frame		A	B	C			
Applicable Motor Output (kW)		0.75	1.5	2.2	3	3.7	
Applicable Motor Output (HP)		1	2	3	4	5	
Inverter Output	Heavy Duty	Rated Output Current (A)	2.7	4.2	5.5	7.3	9
	Normal Duty	Rated Output Current (A)	3	4.6	6.5	8	10.5
Input	Rated Voltage / Frequency		Three Phsaae AC 380 V ~ 480 V (-15% ~ +10%) , 50/60 Hz				
	Operating Voltage (V _{AC})		323 ~ 528 V				
	Mains Frequency Range (Hz)		47 ~ 63 Hz				
Carrier Frequency (kHz)		2~15 (defaut 4)					
Brake Chopper		Built-in					
DC reactor		Optional					
AC reactor		Optional					
Cooling Method		Plate-mount model, matching the heat dissipation method of customer equipment					
Size: W x H (mm)		68 x 162	72 x 162	129 x 157			
Size: D (mm)		110.6	110.6	110.8			



General Specifications and Accessories

Control Functions	Control Methods	V/F, SVC, FOC Sensorless
	Applicant Motors	Induction motors (IM), interior permanent magnet (IPM) motors, and surface permanent magnet (SPM) motors
	Max. Output Frequency	Standard model: 599.00Hz/High speed model: 1500.0Hz (with derating, V/F control only)
	Starting Torque*	150%/3Hz (V/f, SVC control for IM, heavy duty) 100%/(1/20 of motor rated frequency) (SVC control for PM, heavy duty) 200%/0.5Hz (FOC Sensorless control for IM, heavy duty)
	Speed Control Range*	1:50 (V/f, SVC control for IM, heavy duty) 1:20 (SVC control for PM, heavy duty) 1:100 (FOC Sensorless control for IM, heavy duty)
	Overload Tolerance	Normal Duty (ND): 120% of rated output current for 60 seconds; 150% of rated output current for 3 seconds Heavy Duty (HD): 150% of rated output current for 60 seconds; 200% of rated output current for 3 seconds
	Frequency Setting Signal	0 ~ +10V / -10V ~ +10V, 4 ~ 20mA / 0 ~ +10V, 1 pulse input (33kHz), 1 pulse output (33kHz)
	Main Control Functions	Multiple motor switches (max. 4 independent motor parameter settings), fast run, Deceleration Energy Back (DEB) function, wobble frequency function, fast deceleration function, master and auxiliary frequency source selectable, momentary power loss ride thru, speed search, over-torque detection, 16-step speed (max.), accel/decel time switch, S-curve accel/decel, 3-wire sequence, JOG frequency, upper/lower limits for frequency reference, DC injection braking at start and stop, 2 sets of PID controls, built-in PLC (2k steps), simple positioning function, Modbus integrated as standard
Protection Functions	Motor Protection	Overcurrent protection, overvoltage protection, over-temperature protection, phase failure protection
	Stall Prevention	Stall prevention during acceleration, deceleration and running independently
Accessories	Communication Cards	PROFIBUS DP, DeviceNet, Modbus TCP, EtherNet/IP, CANopen, EtherCAT, PROFINET
	External DC power supply	EMM-BPS02 (DC 24V power supply card)
Digital Controller		A removable keypad as standard
Certifications		UL, CE, TUV, RoHS, RCM, REACH

*Control accuracy may vary depending on the environment, application conditions, different motors or encoder. For details, please contact our company or your local distributor.

MS300 Operating Environment

Operating Environment	Installation Location	IEC60364-1/IEC60664-1 Pollution degree 2, Indoor use only		
	Ambient Temperature (°C)	Operation	IP20/UL Open Type	-20 to 50 -20 to 60 (needs derating)
			IP40/NEMA 1/UL Type 1	-20 to 40 -20 to 50 (needs derating)
			IP66/NEMA 4X/UL Type 4X	-20 to 40 -20 to 50 (needs derating)
			Zero stacking Installation	
		The cooling requirements for the base plate of the plate drive	The base plate temperature must not exceed 90° C	
	Storage	-40 to 85		
	Transportation	-20 to 70		
	Rated Humidity	Operation	Max. 90%	
		Storage/Transportation	Max. 95%	
	Air Pressure (kPa)	Operation	86 ~ 106	
		Storage/Transportation	70 ~ 106	
	Pollution Level	Compliance to IEC60721-3-3, 3C2		
Altitude	An altitude of 0 ~ 1000 m for normal operation (derating is required for installation at an altitude above 1000 m)			
Vibration		Compliance to IEC 60068-2-6		
Shock		Compliance to IEC/EN 60068-2-27		

Please refer to MS300 user manual for more details.

Wiring

Input: Single-phase / 3-phase power

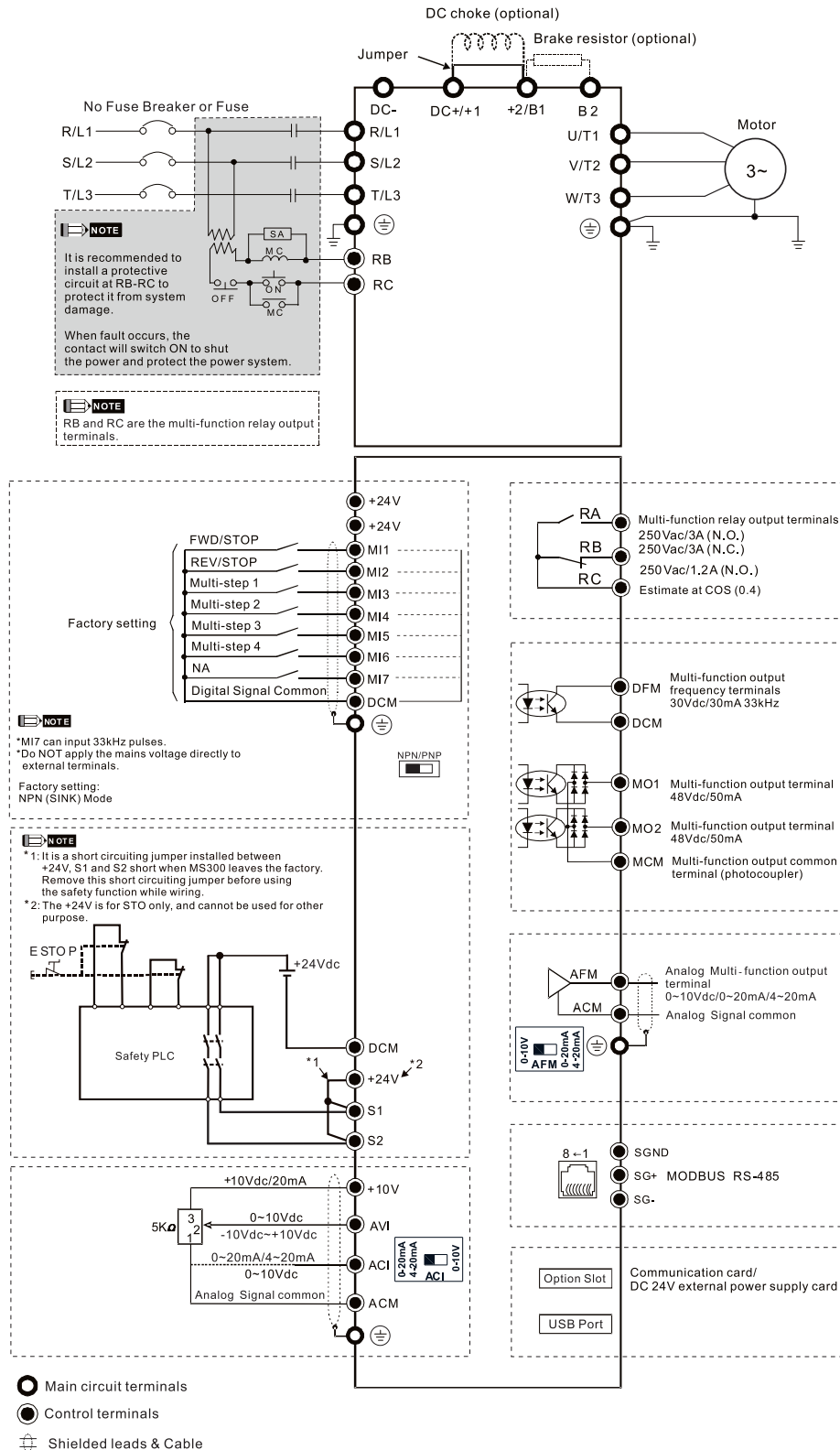

Dimensions: IP20 / IP40 Models

Frame A

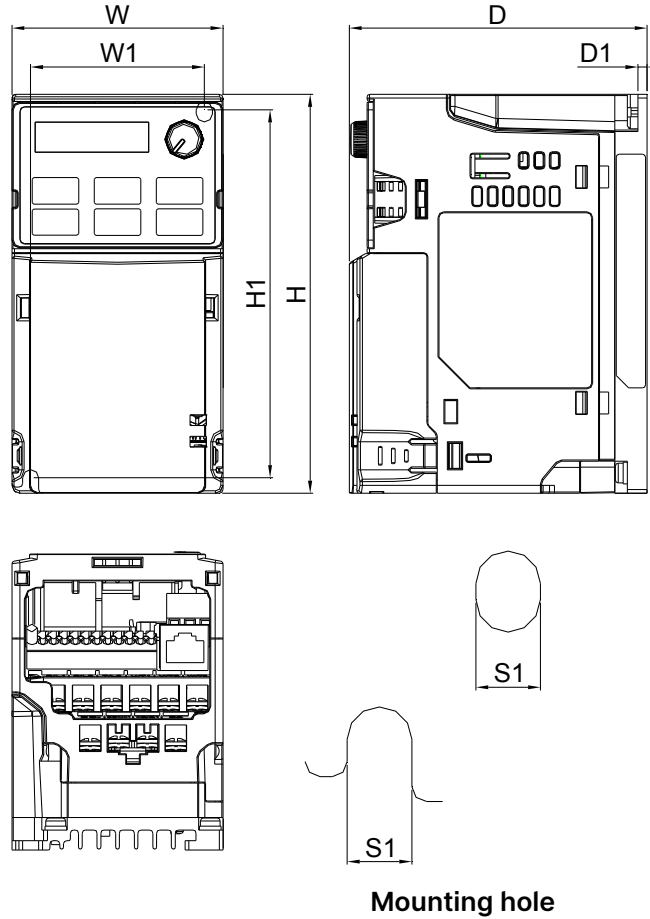

Mounting hole

MODEL	FRAME A2	FRAME A3	FRAME A4	FRAME A5
VFD1A6MS11ANSAA	VFD2A8MS23ANSAA	VFD2A5MS11ANSAA	VFD1A5MS43ANSAA	VFD4A8MS23ANSAA
VFD1A6MS11ENSAA	VFD2A8MS23ENSAA	VFD2A5MS11ENSAA	VFD1A5MS43ENSAA	VFD4A8MS23ENSAA
VFD1A6MS21ANSAA		VFD2A8MS21ANSAA		VFD2A7MS43ANSAA
VFD1A6MS21ENSAA		VFD2A8MS21ENSAA		VFD2A7MS43ENSAA
VFD1A6MS23ANSAA				VFD1A7MS53ANSAA
VFD1A6MS23ENSAA				

Frame	W	H	D	W1	H1	D1	S1
A1	mm	68.0	128.0	96.0	56.0	118.0	3.0
	inch	2.68	5.04	3.78	2.20	4.65	0.12
A2	mm	68.0	128.0	110.0	56.0	118.0	3.0
	inch	2.68	5.04	4.33	2.20	4.65	0.12
A3	mm	68.0	128.0	125.0	56.0	118.0	3.0
	inch	2.68	5.04	4.92	2.20	4.65	0.12

Frame	W	H	D	W1	H1	D1	S1
A4	mm	68.0	128.0	129.0	56.0	118.0	3.0
	inch	2.68	5.04	5.08	2.20	4.65	0.12
A5	mm	68.0	128.0	143.0	56.0	118.0	3.0
	inch	2.68	5.04	5.63	2.20	4.65	0.12

Dimensions: IP20/IP40 Models

Frame B

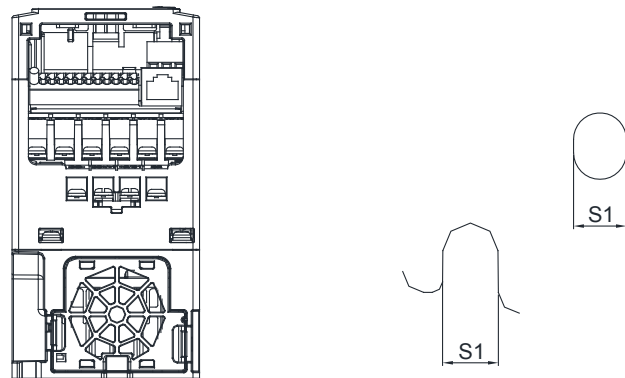
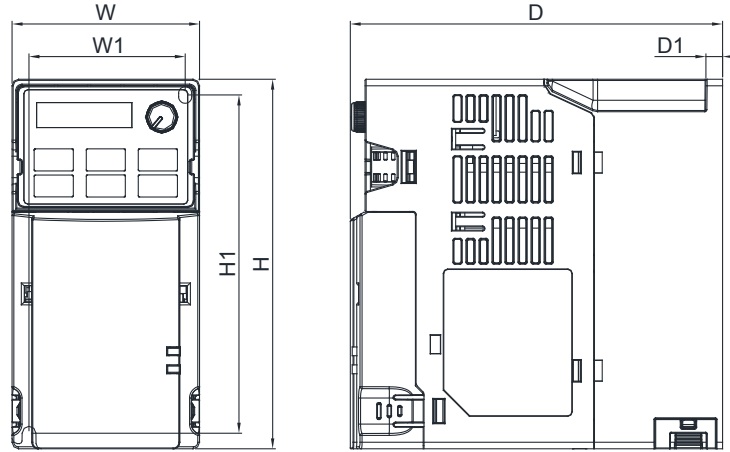

Mounting hole

MODEL	FRAME B1	FRAME B2	FRAME B3
Standard Models:	VFD7A5MS23ANSAA VFD7A5MS23ENSAA VFD4A2MS43ANSAA VFD4A2MS43ENSAA VFD3A0MS53ANSAA	High Speed Models: VFD7A5MS23ANSHA VFD7A5MS23ENSHA VFD4A2MS43ANSHA VFD4A2MS43ENSHA	Standard Models: VFD4A8MS21ANSAA VFD4A8MS21ENSAA
			Standard Models: VFD1A6MS21AFSAA VFD2A8MS21AFSAA VFD4A8MS21AFSAA VFD1A5MS43AFSAA VFD2A7MS43AFSAA VFD4A2MS43AFSAA
			High Speed Models: VFD4A2MS43AFSHA

Frame		W	H	D	W1	H1	D1	S1
B1	mm	72.0	142.0	143.0	60.0	130.0	6.4	5.2
	inch	2.83	5.59	5.63	2.36	5.12	0.25	0.20
Frame		W	H	D	W1	H1	D1	S1
B2	mm	72.0	142.0	143.0	60.0	130.0	3.0	5.2
	inch	2.83	5.59	5.63	2.36	5.12	0.12	0.20
Frame		W	H	D	W1	H1	D1	S1
B3	mm	72.0	142.0	159.0	60.0	130.0	4.3	5.2
	inch	2.83	5.59	6.26	2.36	5.12	0.17	0.20

Dimensions: IP20 / IP40 Models

Frame C

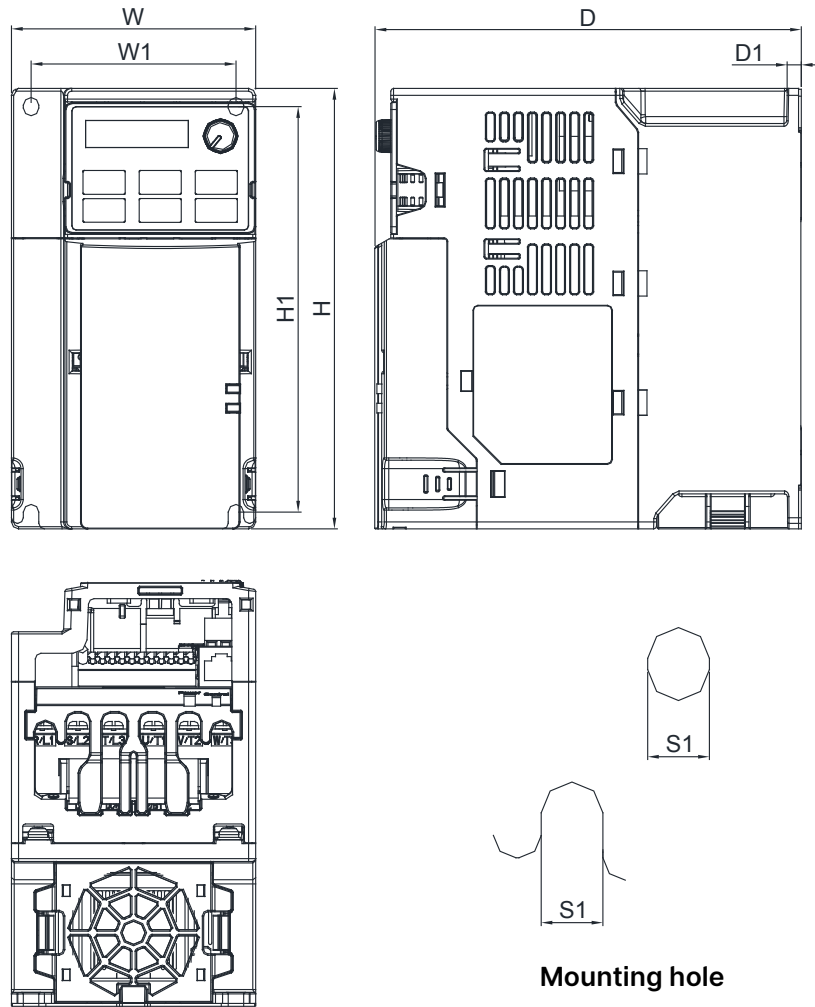

MODEL FRAME C1

Standard Models:

VFD4A8MS11ANSAA VFD4A8MS11ENSAA
 VFD7A5MS21ANSAA VFD7A5MS21ENSAA
 VFD11AMS21ANSAA VFD11AMS21ENSAA
 VFD11AMS23ANSAA VFD11AMS23ENSAA
 VFD17AMS23ANSAA VFD17AMS23ENSAA
 VFD5A5MS43ANSAA VFD5A5MS43ENSAA
 VFD9A0MS43ANSAA VFD9A0MS43ENSAA
 VFD4A2MS53ANSAA VFD6A6MS53ANSAA

High Speed Models:

VFD7A5MS21ANSHA VFD7A5MS21ENSHA
 VFD11AMS21ANSHA VFD11AMS21ENSHA
 VFD11AMS23ANSHA VFD11AMS23ENSHA
 VFD17AMS23ANSHA VFD17AMS23ENSHA
 VFD5A5MS43ANSHA VFD5A5MS43ENSHA
 VFD9A0MS43ANSHA VFD9A0MS43ENSHA

FRAME C2

Standard Models:

VFD7A5MS21AFSAA VFD7A5MS21AFSHA
 VFD11AMS21AFSAA VFD11AMS21AFSHA
 VFD5A5MS43AFSAA VFD5A5MS43AFSHA
 VFD9A0MS43AFSAA VFD9A0MS43AFSHA

High Speed Models:

Frame		W	H	D	W1	H1	D1	S1
C1	mm	87.0	157.0	152.0	73.0	144.5	5.0	5.5
	inch	3.43	6.18	5.98	2.87	5.69	0.20	0.22
Frame		W	H	D	W1	H1	D1	S1
C2	mm	87.0	157.0	179.0	73.0	144.5	5.0	5.5
	inch	3.43	6.18	7.05	2.87	5.69	0.20	0.22

Dimensions: IP20/IP40 Models

Frame D

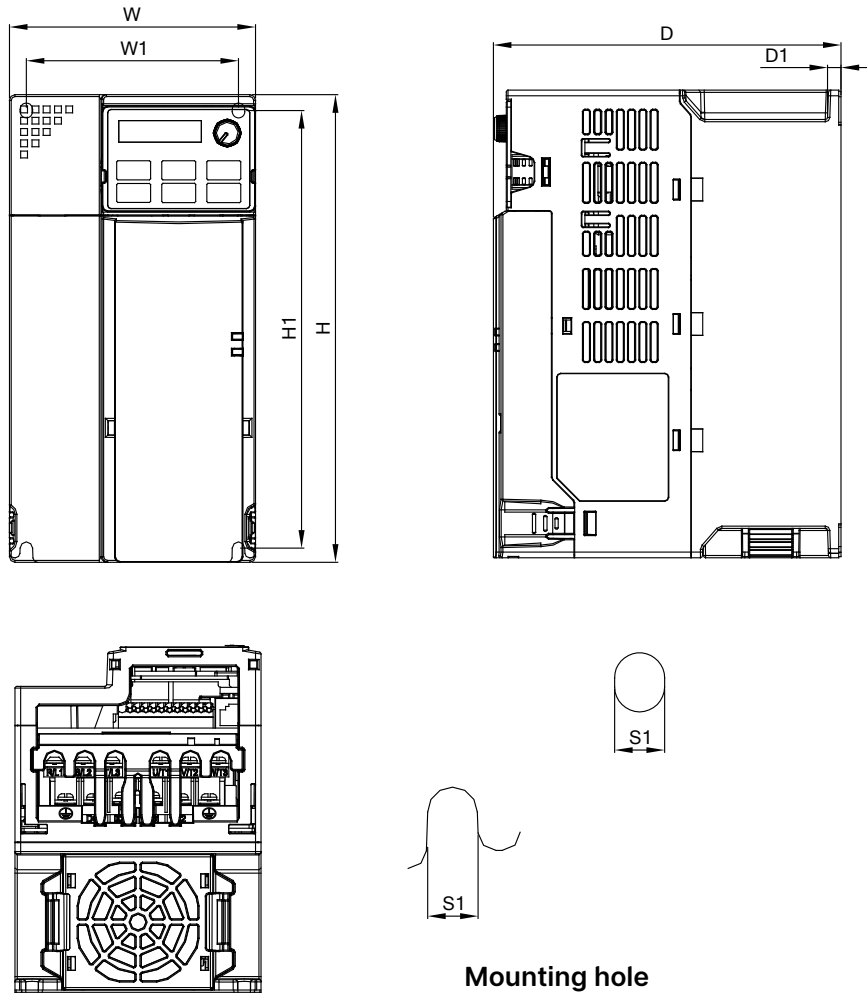

Mounting hole

MODEL FRAME D1

Standard Models:
 VFD25AMS23ANSAA
 VFD25AMS23ENSAA
 VFD13AMS43ANSAA
 VFD13AMS43ENSAA
 VFD17AMS43ANSAA
 VFD17AMS43ENSAA
 VFD9A9MS53ANSAA

High Speed Models:
 VFD25AMS23ANSHA
 VFD25AMS23ENSHA
 VFD13AMS43ANSHA
 VFD13AMS43ENSHA
 VFD17AMS43ANSHA
 VFD17AMS43ENSHA
 VFD12AMS53ANSAA

FRAME D2

Standard Models:
 VFD13AMS43AFSAA
 VFD17AMS43AFSAA

High Speed Models:
 VFD13AMS43AFSHA
 VFD17AMS43AFSHA

Frame		W	H	D	W1	H1	D1	S1
D1	mm	109.0	207.0	154.0	94.0	193.8	6.0	5.5
	inch	4.29	8.15	6.06	3.70	7.63	0.24	0.22
Frame		W	H	D	W1	H1	D1	S1
D2	mm	109.0	207.0	187.0	94.0	193.8	6.0	5.5
	inch	4.29	8.15	7.36	3.70	7.36	0.24	0.22

Dimensions: IP20 / IP40 Models

Frame E

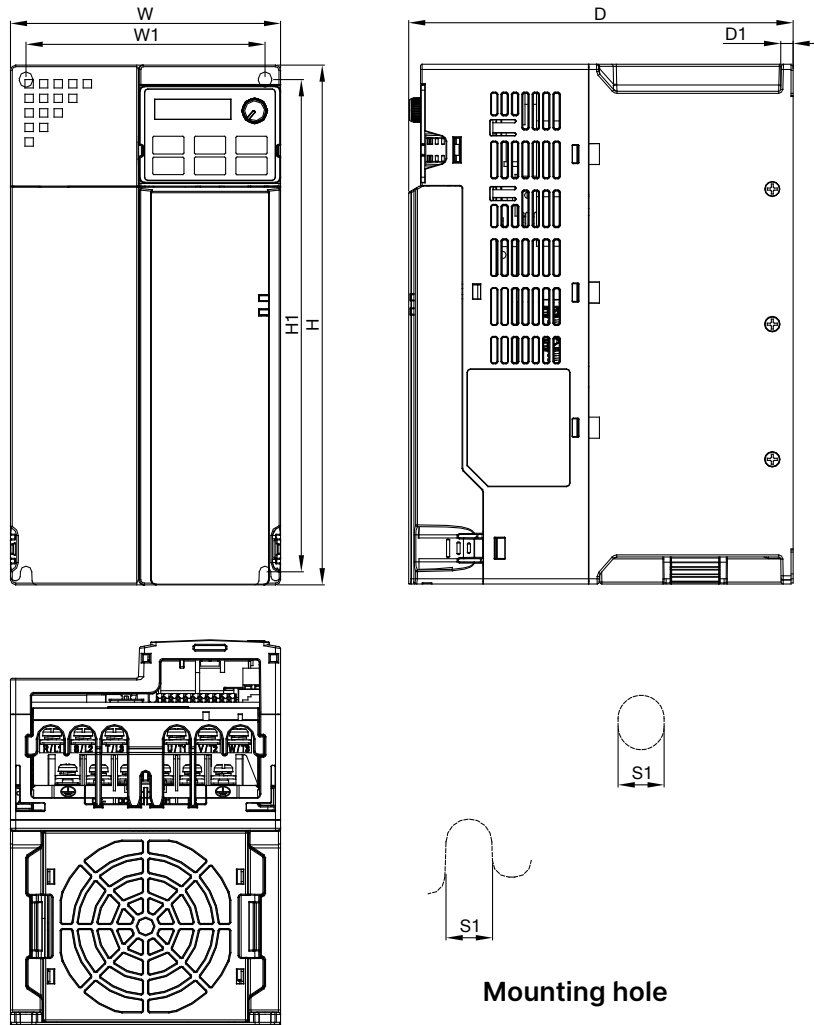

Mounting hole

MODEL FRAME E1

Standard Models:
 VFD33AMS23ANSAA
 VFD33AMS23ENSAA
 VFD49AMS23ANSAA
 VFD49AMS23ENSAA
 VFD25AMS43ANSAA
 VFD25AMS43ENSAA
 VFD32AMS43ANSAA
 VFD32AMS43ENSAA

High Speed Models:
 VFD33AMS23ANSHA
 VFD33AMS23ENSHA
 VFD49AMS23ANSHA
 VFD49AMS23ENSHA
 VFD25AMS43ANSHA
 VFD25AMS43ENSHA
 VFD32AMS43ANSHA
 VFD32AMS43ENSHA

FRAME E2

Standard Models:
 VFD25AMS43AFSAA
 VFD32AMS43AFSAA

High Speed Models:
 VFD25AMS43AFSHA
 VFD32AMS43AFSHA

Frame		W	H	D	W1	H1	D1	S1
E1	mm	130.0	250.0	185.0	115.0	236.8	6.0	5.5
	inch	5.12	9.84	7.83	4.53	9.32	0.24	0.22
Frame		W	H	D	W1	H1	D1	S1
E2	mm	130.0	250.0	219.0	115.0	236.8	6.0	5.5
	inch	5.12	9.84	8.62	4.53	9.32	0.24	0.22

Dimensions: IP20/IP40 Models

Frame F

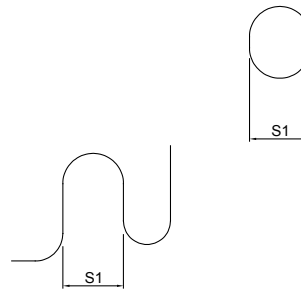
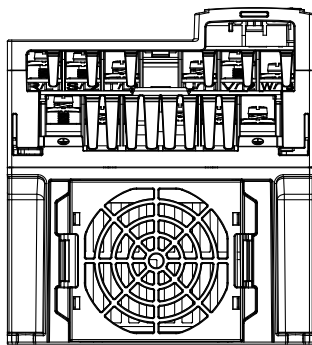
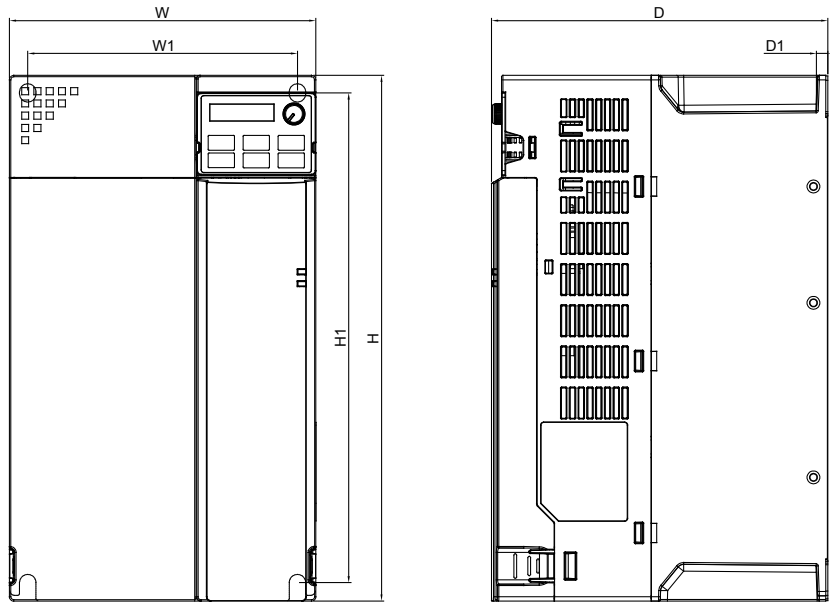

Mounting hole

MODEL FRAME F1

Standard Models:
 VFD65AMS23ANSAA
 VFD65AMS23ENSAA
 VFD38AMS43ANSAA
 VFD38AMS43ENSAA
 VFD45AMS43ANSAA
 VFD45AMS43ENSAA

High Speed Models:
 VFD65AMS23ANSHA
 VFD65AMS23ENSHA
 VFD38AMS43ANSHA
 VFD38AMS43ENSHA
 VFD45AMS43ANSHA
 VFD45AMS43ENSHA

FRAME F2

Standard Models:
 VFD38AMS43AFSAA
 VFD45AMS43AFSAA

High Speed Models:
 VFD38AMS43AFSHA
 VFD45AMS43AFSHA

Frame		W	H	D	W1	H1	D1	S1
F1	mm	175.0	300.0	192.0	154.0	279.5	6.5	8.4
	inch	6.89	11.81	7.56	6.06	11.00	0.26	0.33
Frame		W	H	D	W1	H1	D1	S1
F2	mm	175.0	300.0	244.0	154.0	279.5	6.5	8.4
	inch	6.89	11.81	9.61	6.06	11.00	0.26	0.33

Dimensions: IP66 /NEMA 4X Models

Frame A

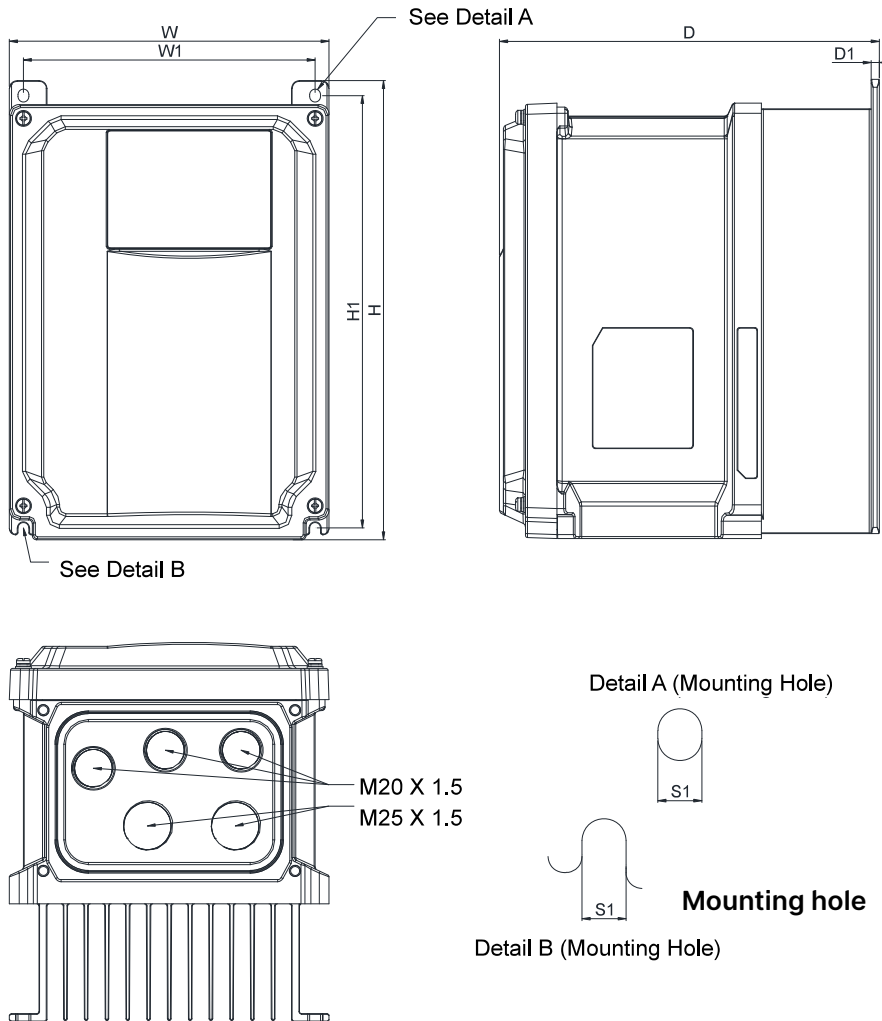

MODEL	FRAME A2	FRAME A3
FRAME A1		
VFD2A8MS21MNSAA	VFD2A8MS23MNSAA	VFD7A5MS21MNSAA
VFD1A5MS43MFSAA	VFD4A8MS21MFSAA	VFD7A5MS23MNSAA
VFD2A7MS43MNSAA	VFD1A5MS43MNSAA	VFD4A2MS43MNSAA
VFD2A8MS21MFSAA	VFD4A8MS23MNSAA	VFD4A2MS43MFSAA
VFD4A8MS21MNSAA		
VFD2A7MS43MFSAA		

Frame		W	H	D	W1	H1	D1	S1
A1	mm	160.0	230.0	151.0	146.0	216.5	4.0	5.5
	inch	6.30	9.06	6.57	5.75	8.52	0.16	0.22
Frame		W	H	D	W1	H1	D1	S1
A2	mm	160.0	230.0	167.0	146.0	216.5	4.0	5.5
	inch	6.30	9.06	6.57	5.75	8.52	0.16	0.22
Frame		W	H	D	W1	H1	D1	S1
A3	mm	160.0	230.0	190.0	146.0	216.5	4.0	5.5
	inch	6.30	9.06	7.48	5.75	8.52	0.16	0.22

Dimensions: IP66 / NEMA 4X Models

Frame B

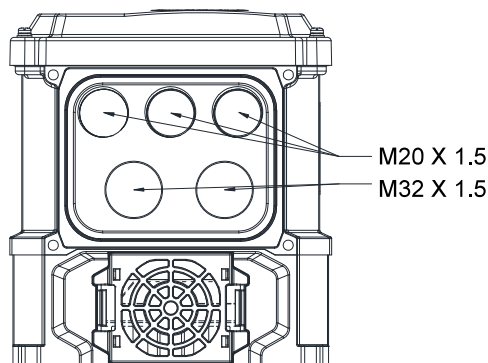
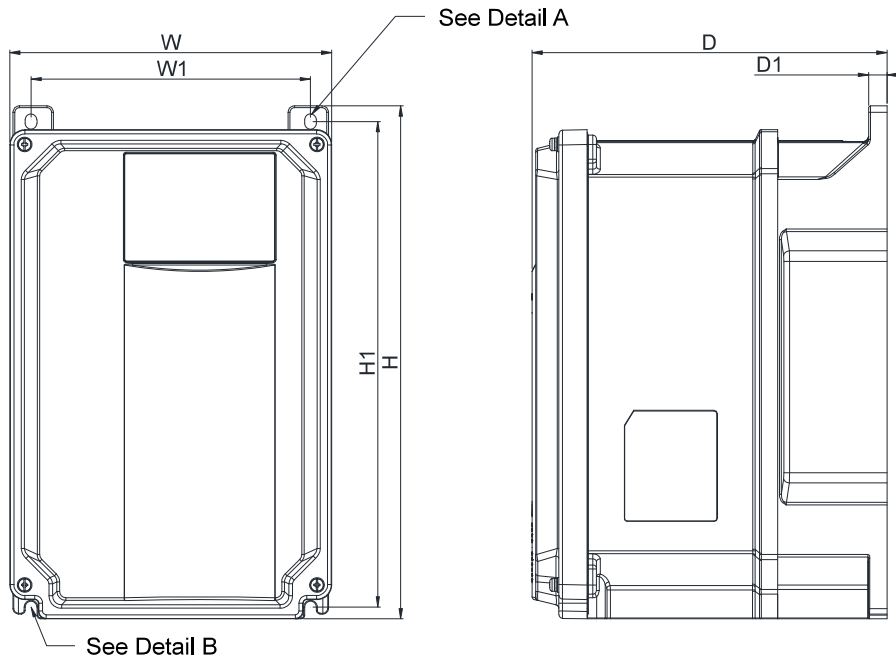

Detail A (Mounting Hole)

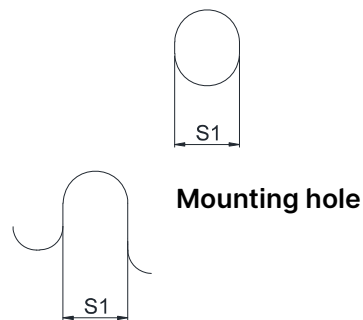

Mounting hole

**MODEL
FRAME B**

VFD7A5MS21MFSAA	VFD11AMS21MNSAA	VFD11AMS21MFSAA	VFD11AMS23MNSAA
VFD5A5MS43MFSAA	VFD17AMS23MNSAA	VFD9A0MS43MNSAA	VFD9A0MS43MFSAA

Frame		W	H	D	W1	H1	D1	S1
B	mm	175.0	280.0	193.0	152.0	266.0	10	6.4
	inch	6.89	11.02	7.60	5.98	10.43	0.39	0.25

Dimensions: IP66 / NEMA 4X Models

Frame C

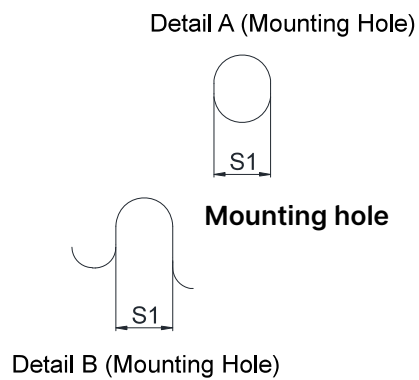
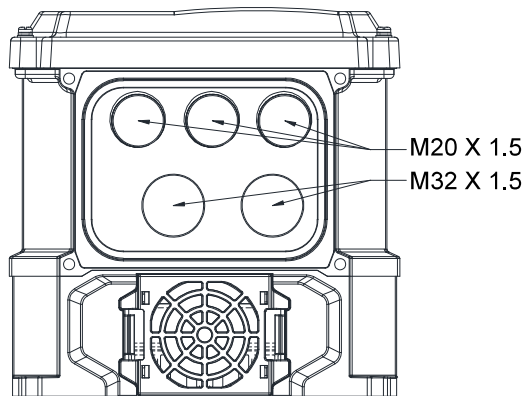
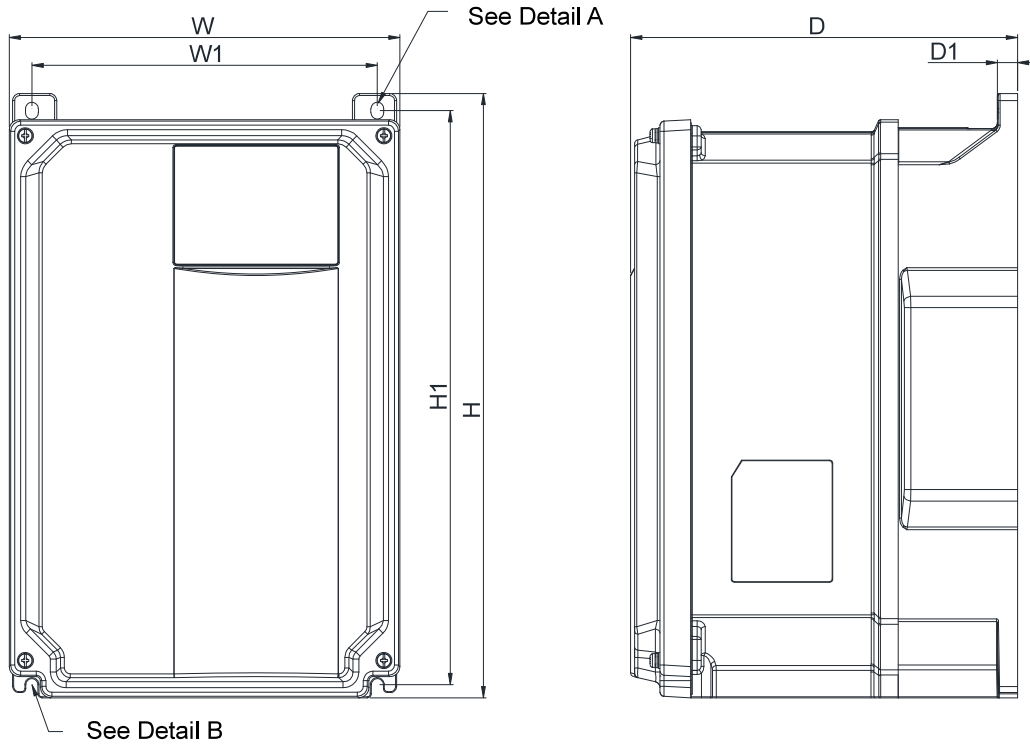

MODEL FRAME C

VFD13AMS43MNSAA VFD13AMS43MFSAA VFD25AMS23MNSAA VFD17AMS43MNSAA
VFD17AMS43MFSAA

Frame	W	H	D	W1	H1	D1	S1
C	mm	195.0	300.0	193.0	172.4	285.0	6.4
	inch	7.68	11.81	7.606	6.79	11.22	0.25

Dimensions: Plate-mount Type

Frame A

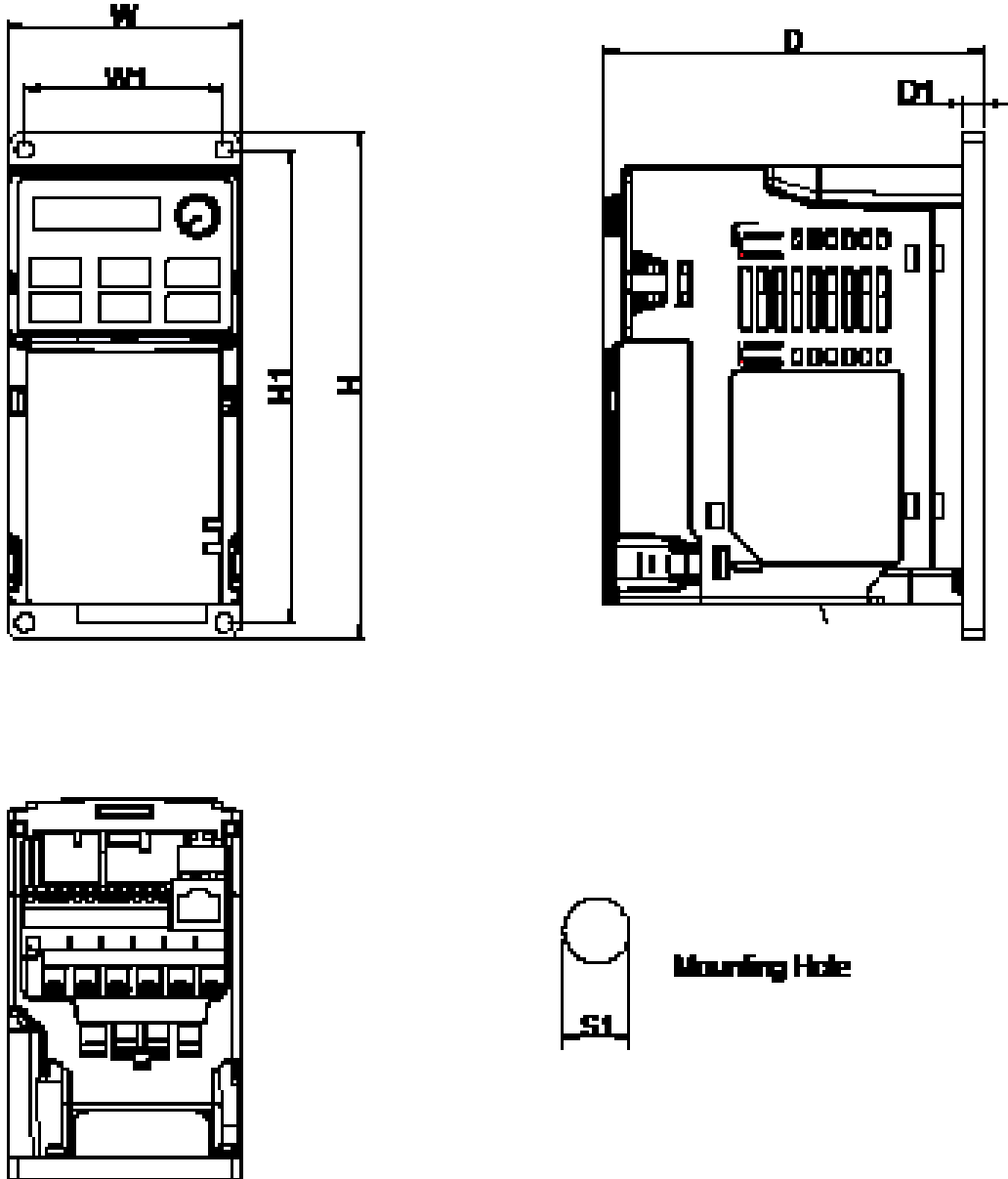

Models
Frame A

Plate Mount Models :
VFD2A7MS43PNSAA

Frame		W	W1	H	H1	D	D1	S1
A	mm	68.0	58.0	148.0	138.0	110.6	6.0	5.0
	inch	2.68	2.28	5.83	5.43	4.35	0.24	0.20

Dimensions: Plate-mount Type

Frame B

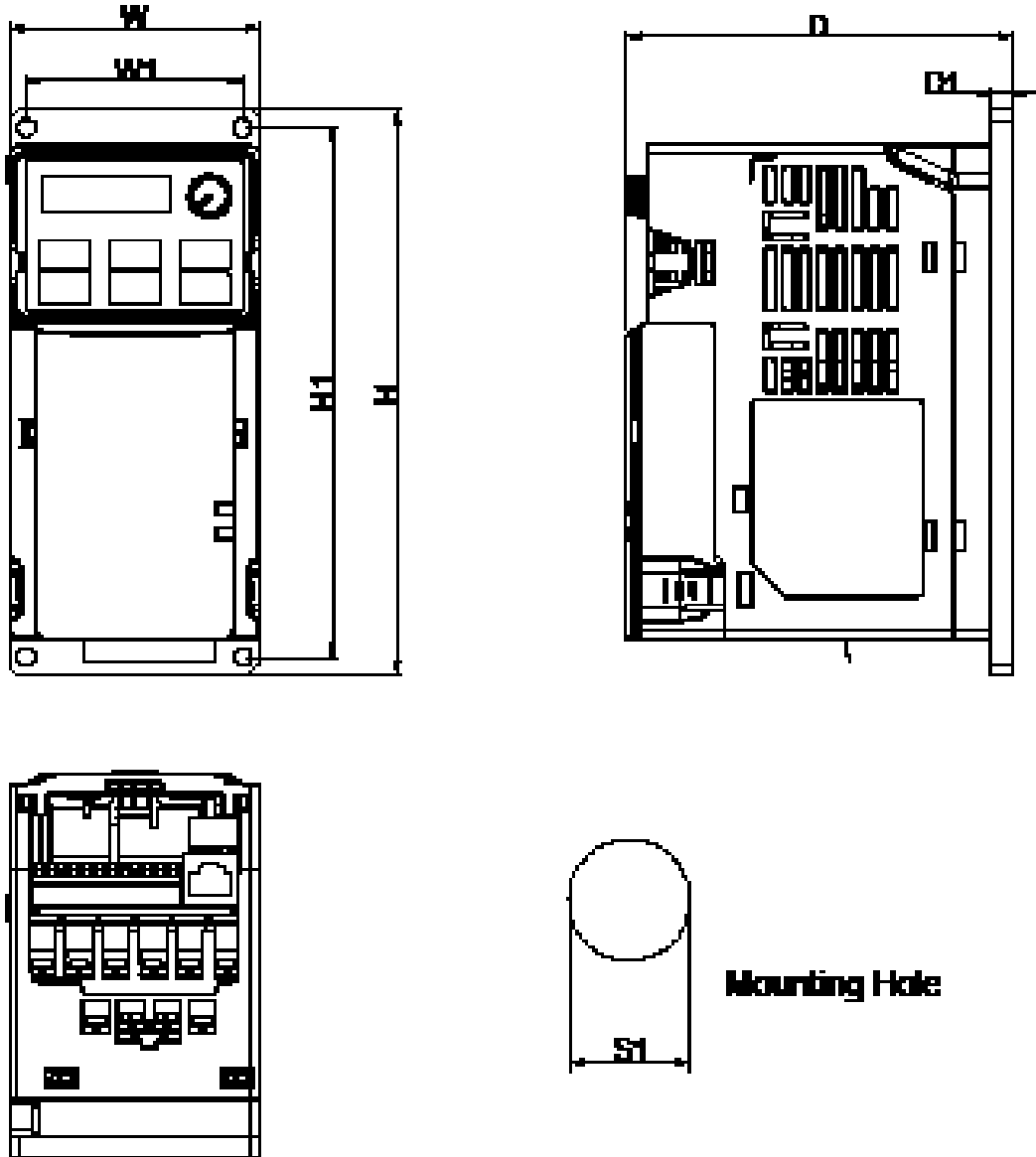

Models Frame B

Plate Mount Models :
VFD4A2MS43PNSAA

Frame		W	W1	H	H1	D	D1	S1
B	mm	72.0	62.0	162.0	152.0	110.6	6.0	5.0
	inch	2.83	2.44	6.38	5.98	4.35	0.24	0.20

Dimensions: Plate-mount Type

Frame C

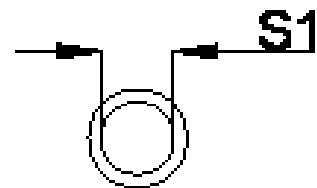
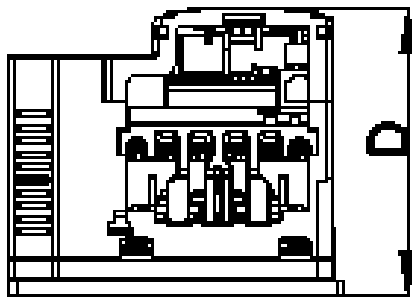
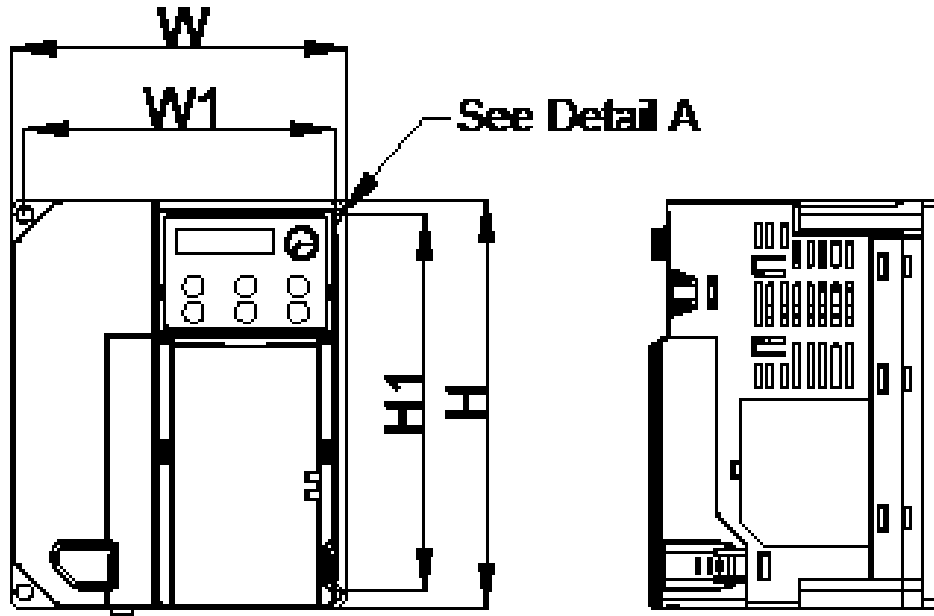

Detail A (Mounting Hole)

Models Frame C

Plate Mount Models :
VFD5A5MS43PNSAA
VFD7A3MS43PNSAA
VFD9A0MS43PNSAA

Frame		W	W1	H	H1	D	S1
C	mm	129.0	119.0	157.0	145.0	110.8	5.5
	inch	5.08	4.69	6.18	5.71	5.04	0.22

Accessories

The matched connection cables (CBM-CLxxA 、CBM-CCxxA) are required for usage. Please refer to the user manual for detailed ordering information.

■ PROFINET Option Card NEW

CMM-PN02



Features

- ▶ Supports PROFINET IO/RT
- ▶ Profibus and Profinet International (PI) certificate

Network Interface

Network protocol	PROFIBUS DP	Interface	DB9
Transmission speed	9.6 Kbps / 19.2 Kbps / 93.75 Kbps / 187.5 Kbps / 500 Kbps / 1.5 Mbps / 3 Mbps / 6 Mbps / 12 Mbps	Number of port	2
Transmission method	Periodic / non-periodic data exchange	Transmission cable	DMCNET
Transmission distance	100 m / 12 Mbps		

■ EtherCAT Option Card NEW

CMM-EC02 / CMM-EC03



Features

- ▶ Supports Ethernet CAT protocol
- ▶ Supports standard CiA402 speed mode
- ▶ Supports SDO (Service Data Objects) function: Drive status reading and parameters editing
- ▶ Auto shutdown function for interruptions during data transmission
- ▶ Supports remote I/O function
- ▶ CMM-EC03 supports Dynamic Recognition

Network Interface

Interface	RJ-45	Transmission cable	Category 5e shielding 100 M
Number of ports	2	Transmission speed	100 Mbps
Transmission method	IEEE 802.3, IEEE 802.3u	Network protocol	EtherCAT

■ CANopen Option Card

CMM-COP02



Features

- ▶ Complies with CiA 402 standard (default setting)
- ▶ 4 sets of RX/TX PDO
- ▶ Dual communication ports
- ▶ Node address and Baud rate can be set in the AC motor drive
- ▶ Supports Delta protocol, DMCNET
- ▶ Supports remote I/O function

Network Interface

Network protocol	CANopen	Interface	RJ-45
Transmission speed	1Mbps / 500 Kbps / 250 Kbps / 125 Kbps / 100 Kbps / 50 Kbps	Number of ports	2
Transmission method	PDO, SDO	Transmission cable	Delta standard
Transmission distance	25 m / 1 Mbps		

▪ PROFIBUS DP Option Card

CMM-PD02



Features

- ▶ Supports PZD cyclic data exchange
- ▶ Supports PKW read/write to AC motor drive parameters
- ▶ Supports user diagnosis function
- ▶ Auto-detects baud rates; supports Max.12 Mbps.
- ▶ Supports remote I/O function

Network Interface

Network protocol	PROFIBUS DP	Interface	DB9
Transmission speed	9.6k/19.2k/93.75k/187.5k/500k/1.5M/3M/6M/12Mbps	Number of ports	1
Transmission method	Cyclic/non-cyclic data exchange	Transmission cable	Delta standard
Transmission distance	100m/12Mbps		

▪ EtherNet/IP Option Card

CMM-EIP02 / CMM-EIP03

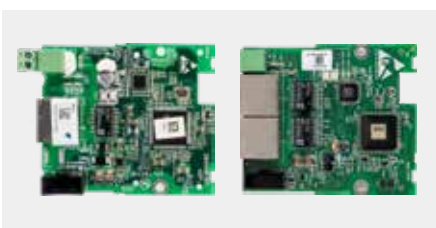

Features

- ▶ Supports max. 32 words input and 32 words output of I/O connection
- ▶ User-defined parameter mapping
- ▶ IP Filter, basic firewall function
- ▶ Supports DLR ring nodes
* Applicable to CMM-EIP03

Network Interface

Network protocol	DHCP、BOOTP、EtherNet/IP、Modbus TCP	Interface	RJ-45
Transmission speed	10/100Mbps	Number of port	1(CMM-EIP02) / 2(CMM-EIP03)
Transmission method	I/O connection/Explicit message	Transmission cable	Category 5e shielding
Transmission distance	100m, extension is allowed via switch		

▪ DeviceNet Option Card

CMM-DN02



Features

- ▶ Supports Group 2 only connection method and cyclic I/O data exchange
- ▶ Provides EDS file to identify DeviceNet equipment information
- ▶ Supports max. 32 words input and 32 words output of parameter mapping and remote I/O function
- ▶ Node address and Baud rate can be set in the AC motor drive

Network Interface

Network protocol	DeviceNet	Interface	Terminal block
Transmission speed	500k/250k/125k/100k/50k bps and extendable baud rate mode of 1M	Number of ports	1
Transmission method	Explicit message/Implicit message	Transmission cable	Delta standard
Transmission distance	25 m/1Mbps		

24V Power Shift Card

EMM-BPS02

Terminals	Description
 PE GND 24 V	When the AC motor drive power is off, the external power supply card provides external power to the network system, PLC function, and other functions to allow continued operations. Input power: 24 V ± 5% Maximum input current: 0.5 A Note: 1) Do not connect the control terminal +24 V (Digital control signal common: SOURCE) directly to the EMC-BPS01 input terminal 24 V. 2) Do not connect control terminal GND directly to the EMC-BPS01 input terminal GND in order to achieve good isolation.

Note 1: For the Open Collector, set input voltage to 5~15mA and install a pull-up resistor

[5V] Recommend pull-up resistor: 100~220Ω, 1/2W and above

[12V] Recommend pull-up resistor: 510~1.35KΩ, 1/2W and above

[24V] Recommend pull-up resistor: 1.8K~3.3KΩ, 1/2W and above

Screw Specification of Option Card Terminals

Screw Specification of Option Card Terminals	Wire Gauge	Torque
CMM-COP02	30~16 AWG (0.0509 ~ 1.31 mm ²)	2 Kg-cm [1.74 lb-in]
CMM-EIP02 / CMM-EIP03		
CMM-PD02		
CMM-DN02		
EMM-BPS02	30~16 AWG (0.0509 ~ 1.31 mm ²)	8 Kg-cm [6.94 lb-in]

Accessories

Standard Fieldbus Cables

Delta Cables	Part Number	Description	Length
CANopen Cable	UC-CMC003-01A	CANopen cable, RJ45 connector	0.3m
	UC-CMC005-01A	CANopen cable, RJ45 connector	0.5m
	UC-CMC010-01A	CANopen cable, RJ45 connector	1m
	UC-CMC015-01A	CANopen cable, RJ45 connector	1.5m
	UC-CMC020-01A	CANopen cable, RJ45 connector	2m
	UC-CMC030-01A	CANopen cable, RJ45 connector	3m
	UC-CMC050-01A	CANopen cable, RJ45 connector	5m
	UC-CMC100-01A	CANopen cable, RJ45 connector	10m
DeviceNet Cable	UC-CMC200-01A	CANopen cable, RJ45 connector	20m
	UC-DN01Z-01A	DeviceNet cable	305m
	UC-DN01Z-02A	DeviceNet cable	305m
	EtherNet/EtherCAT Cable	UC-EMC003-02A	EtherNet/EtherCAT cable, Shielding
UC-EMC005-02A		EtherNet/EtherCAT cable, Shielding	0.5m
UC-EMC010-02A		EtherNet/EtherCAT cable, Shielding	1m
UC-EMC020-02A		EtherNet/EtherCAT cable, Shielding	2m
UC-EMC050-02A		EtherNet/EtherCAT cable, Shielding	5m
UC-EMC100-02A		EtherNet/EtherCAT cable, Shielding	10m
CANopen/DeviceNet TAP	UC-EMC200-02A	EtherNet/EtherCAT cable, Shielding	20m
	TAP-CN01	1 in 2 out, built-in 121 Ω terminal resistor	1 in 2 out
	TAP-CN02	1 in 4 out, built-in 121 Ω terminal resistor	1 in 4 out
PROFIBUS Cable	TAP-CN03	1 in 4 out, RJ45 connector, built-in 121 Ω terminal resistor	1 in 4 out
	UC-PF01Z-01A	PROFIBUS DP cable	305m

Extension Cable for Digital Keypad



Part No.	L	
	mm	[inch]
EG0610C	600	23.6
EG1010C	1000	39.4
EG2010C	2000	78.7
EG3010C	3000	118.1
EG5010C	5000	196.8

Model Name Explanation

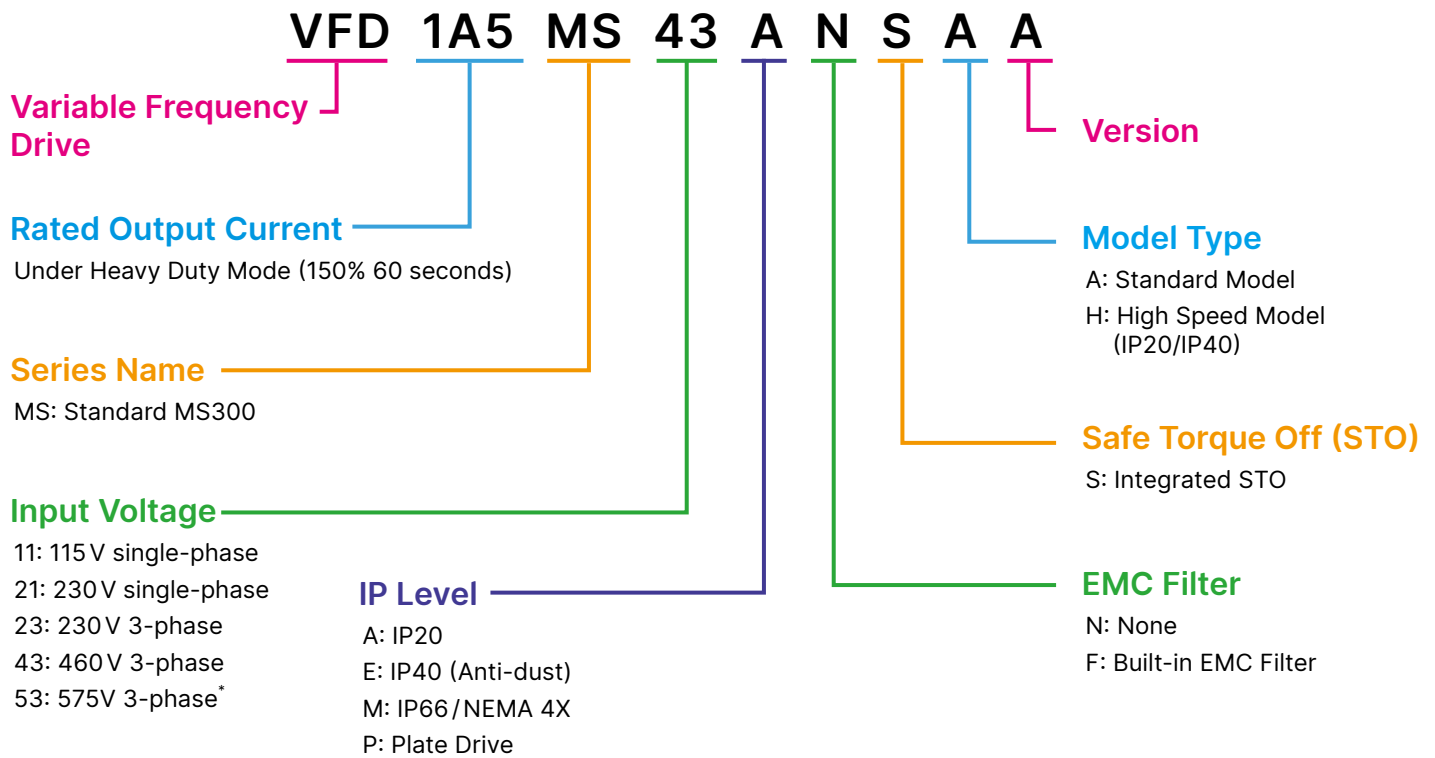

* Only for models with ANSAA at the end of model names

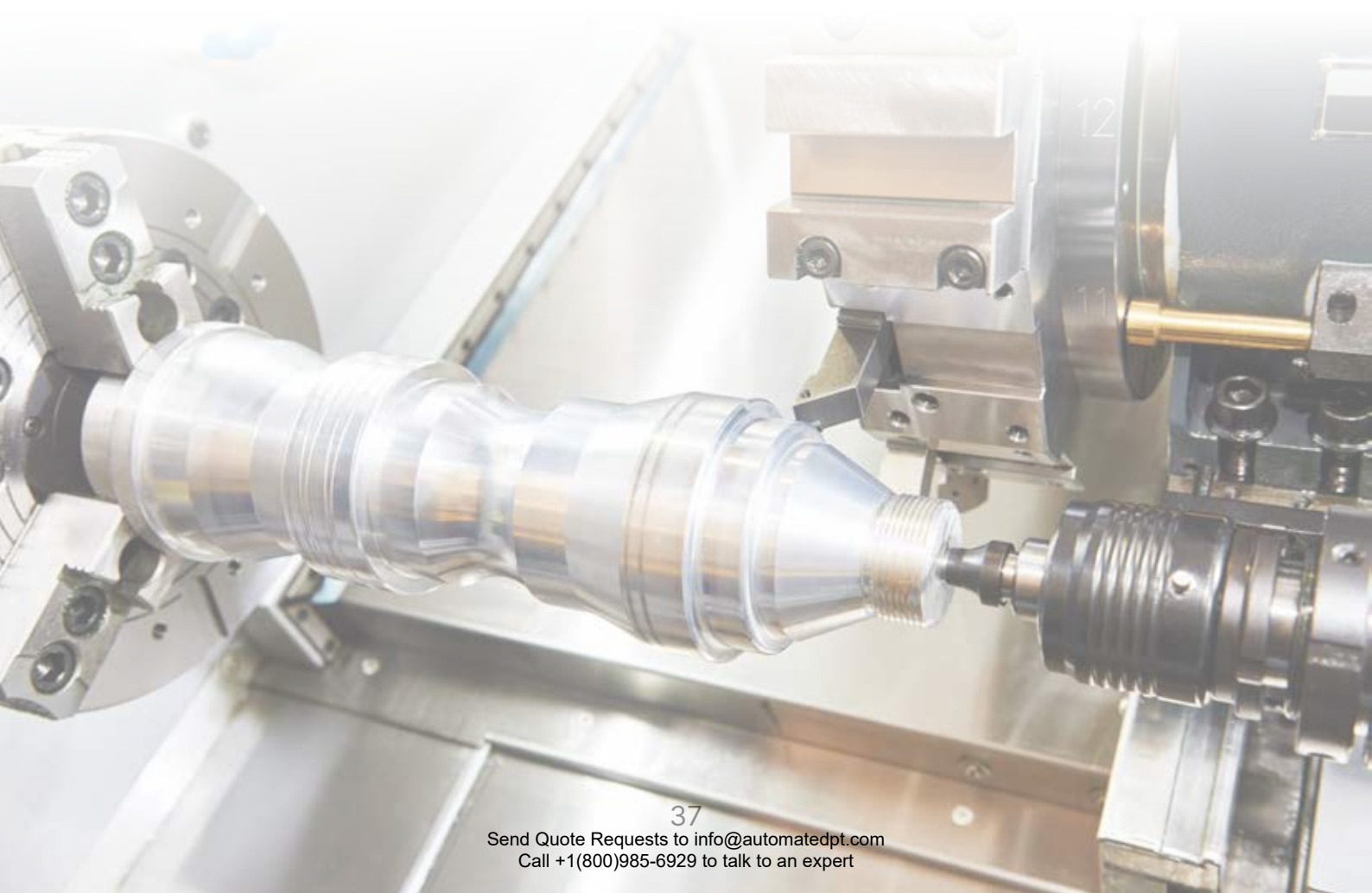

Ordering Information

IP20/IP40 Standard Models (0 ~ 599 Hz)

Power Range			Frame Size	Model Name	Built-in EMC Filter	IP40 Models
Max. Applicable Motor Capacity		Drive Rated Output Current				
[HP]	[kW]	[A]				
115 V / single-phase						
0.25	0.2	1.6	A	VFD1A6MS11ANSAA	-	-
				VFD1A6MS11ENSAA	-	V
0.5	0.4	2.5	A	VFD2A5MS11ANSAA	-	-
				VFD2A5MS11ENSAA	-	V
1	0.75	4.8	C	VFD4A8MS11ANSAA	-	-
				VFD4A8MS11ENSAA	-	V
230 V / single-phase						
1/4	0.2	1.6	A	VFD1A6MS21ANSAA	-	-
			A	VFD1A6MS21ENSAA	-	V
			B	VFD1A6MS21AFSAA	V	-
0.5	0.4	2.8	A	VFD2A8MS21ANSAA	-	-
			A	VFD2A8MS21ENSAA	-	V
			B	VFD2A8MS21AFSAA	V	-
1	0.75	4.8	B	VFD4A8MS21ANSAA	-	-
				VFD4A8MS21AFSAA	V	-
				VFD4A8MS21ENSAA	-	V
2	1.5	7.5	C	VFD7A5MS21ANSAA	-	-
				VFD7A5MS21AFSAA	V	-
				VFD7A5MS21ENSAA	-	V
3	2.2	11.0	C	VFD11AMS21ANSAA	-	-
				VFD11AMS21AFSAA	V	-
				VFD11AMS21ENSAA	-	V
230 V / 3-phase						
0.25	0.2	1.6	A	VFD1A6MS23ANSAA	-	-
				VFD1A6MS23ENSAA	-	V
0.5	0.4	2.8	A	VFD2A8MS23ANSAA	-	-
				VFD2A8MS23ENSAA	-	V
1	0.75	4.8	A	VFD4A8MS23ANSAA	-	-
				VFD4A8MS23ENSAA	-	V
2	1.5	7.5	B	VFD7A5MS23ANSAA	-	-
				VFD7A5MS23ENSAA	-	V
3	2.2	11.0	C	VFD11AMS23ANSAA	-	-
				VFD11AMS23ENSAA	-	V
5	3.7/4	17.0	C	VFD17AMS23ANSAA	-	-
				VFD17AMS23ENSAA	-	V
7.5	5.5	25.0	D	VFD25AMS23ANSAA	-	-
				VFD25AMS23ENSAA	-	V
10	7.5	33.0	E	VFD33AMS23ANSAA	-	-
				VFD33AMS23ENSAA	-	V
15	11	49.0	E	VFD49AMS23ANSAA	-	-
				VFD49AMS23ENSAA	-	V
20	15	65.0	F	VFD65AMS23ANSAA	-	-
				VFD65AMS23ENSAA	-	V

IP20/IP40 Standard Models (0 ~ 599Hz)

Power Range			Frame Size	Model Name	Built-in EMC Filter	IP40 Models
Max. Applicable Motor Capacity		Drive Rated Output Current				
[HP]	[kW]	[A]				
460V/3-phase						
0.5	0.4	1.5	A	VFD1A5MS43ANSAA	-	-
			A	VFD1A5MS43ENSAA	-	V
			B	VFD1A5MS43AFSAA	V	-
1	0.75	2.7	A	VFD2A7MS43ANSAA	-	-
			A	VFD2A7MS43ENSAA	-	V
			B	VFD2A7MS43AFSAA	V	-
2	1.5	4.2	B	VFD4A2MS43ANSAA	-	-
				VFD4A2MS43ENSAA	-	V
				VFD4A2MS43AFSAA	V	-
3	2.2	5.5	C	VFD5A5MS43ANSAA	-	-
				VFD5A5MS43ENSAA	-	V
				VFD5A5MS43AFSAA	V	-
5	3.7/4	9.0	C	VFD9A0MS43ANSAA	-	-
				VFD9A0MS43ENSAA	-	V
				VFD9A0MS43AFSAA	V	-
7.5	5.5	13.0	D	VFD13AMS43ANSAA	-	-
				VFD13AMS43ENSAA	-	V
				VFD13AMS43AFSAA	V	-
10	7.5	17.0	D	VFD17AMS43ANSAA	-	-
				VFD17AMS43ENSAA	-	V
				VFD17AMS43AFSAA	V	-
15	11	25.0	E	VFD25AMS43ANSAA	-	-
				VFD25AMS43ENSAA	-	V
				VFD25AMS43AFSAA	V	-
20	15	32.0	E	VFD32AMS43ANSAA	-	-
				VFD32AMS43ENSAA	-	V
				VFD32AMS43AFSAA	V	-
25	18.5	38.0	F	VFD38AMS43ANSAA	-	-
				VFD38AMS43ENSAA	-	V
				VFD38AMS43AFSAA	V	-
30	22	45.0	F	VFD45AMS43ANSAA	-	-
				VFD45AMS43ENSAA	-	V
				VFD45AMS43AFSAA	V	-
575V/3-phase						
1	0.75	1.7	A	VFD1A7MS53ANSAA	-	-
2	1.5	3.0	B	VFD3A0MS53ANSAA	-	-
3	2.2	4.2	C	VFD4A2MS53ANSAA	-	-
5	3.7	6.6		VFD6A6MS53ANSAA	-	-
7.5	5.5	9.9	D	VFD9A9MS53ANSAA	-	-
10	7.5	12.2		VFD12AMS53ANSAA	-	-

IP20/IP40 High Speed Models (0 ~ 1500 Hz)

Power Range			Frame Size	Model Name	Built-in EMC Filter	IP40 Models
Max. Applicable Motor Capacity		Drive Rated Output Current				
[HP]	[kW]	[A]				
230V / single-phase						
2	1.5	7.5	C	VFD7A5MS21ANSHA	-	-
				VFD7A5MS21ENSHA	-	V
				VFD7A5MS21AFSHA	V	-
3	2.2	11.0	C	VFD11AMS21ANSHA	-	-
				VFD11AMS21ENSHA	-	V
				VFD11AMS21AFSHA	V	-
230V / 3-phase						
2	1.5	7.5	B	VFD7A5MS23ANSHA	-	-
				VFD7A5MS23ENSHA	-	V
3	2.2	11.0	C	VFD11AMS23ANSHA	-	-
				VFD11AMS23ENSHA	-	V
5	3.7/4	17.0	C	VFD17AMS23ANSHA	-	-
				VFD17AMS23ENSHA	-	V
7.5	5.5	25.0	D	VFD25AMS23ANSHA	-	-
				VFD25AMS23ENSHA	-	V
10	7.5	33.0	E	VFD33AMS23ANSHA	-	-
				VFD33AMS23ENSHA	-	V
15	11	49.0	E	VFD49AMS23ANSHA	-	-
				VFD49AMS23ENSHA	-	V
20	15	65.0	F	VFD65AMS23ANSHA	-	-
				VFD65AMS23ENSHA	-	V
460V / 3-phase						
2	1.5	4.2	B	VFD4A2MS43ANSHA	-	-
				VFD4A2MS43ENSHA	-	V
				VFD4A2MS43AFSHA	V	-
3	2.2	5.5	C	VFD5A5MS43ANSHA	-	-
				VFD5A5MS43ENSHA	-	V
				VFD5A5MS43AFSHA	V	-
5	3.7/4	9.0	C	VFD9A0MS43ANSHA	-	-
				VFD9A0MS43ENSHA	-	V
				VFD9A0MS43AFSHA	V	-
7.5	5.5	13.0	D	VFD13AMS43ANSHA	-	-
				VFD13AMS43ENSHA	-	V
				VFD13AMS43AFSHA	V	-
10	7.5	17.0	D	VFD17AMS43ANSHA	-	-
				VFD17AMS43ENSHA	-	V
				VFD17AMS43AFSHA	V	-
15	11	25.0	E	VFD25AMS43ANSHA	-	-
				VFD25AMS43ENSHA	-	V
				VFD25AMS43AFSHA	V	-
20	15	32.0	E	VFD32AMS43ANSHA	-	-
				VFD32AMS43ENSHA	-	V
				VFD32AMS43AFSHA	V	-
25	18.5	38.0	F	VFD38AMS43ANSHA	-	-
				VFD38AMS43ENSHA	-	V
				VFD38AMS43AFSHA	V	-
30	22	45.0	F	VFD45AMS43ANSHA	-	-
				VFD45AMS43ENSHA	-	V
				VFD45AMS43AFSHA	V	-

IP66 Standard Models (0 ~ 599 Hz)

Power Range		Drive Rated Output Current [A]	Frame Size	Model Name	Built-in EMC Filter
Max. Applicable Motor Capacity					
[HP]	[kW]				
230 V / single-phase					
1/2	0.4	2.8	A	VFD2A8MS21MNSAA	-
		2.8		VFD2A8MS21MFSAA	V
1	0.75	4.8	A	VFD4A8MS21MNSAA	-
		4.8		VFD4A8MS21MFSAA	V
2	1.5	7.5	A	VFD7A5MS21MNSAA	-
		7.5	B	VFD7A5MS21MFSAA	V
3	2.2	11	B	VFD11AMS21MNSAA	-
		11		VFD11AMS21MFSAA	V
230 V / 3-phase					
1/2	0.4	2.8	A	VFD2A8MS23MNSAA	-
1	0.75	4.8	A	VFD4A8MS23MNSAA	-
2	1.5	7.5	A	VFD7A5MS23MNSAA	-
3	2.2	11	B	VFD11AMS23MNSAA	-
5	3.7	17	B	VFD17AMS23MNSAA	-
7.5	5.5	25	C	VFD25AMS23MNSAA	-
460 V / 3-phase					
1/2	0.4	1.5	A	VFD1A5MS43MNSAA	-
		1.5		VFD1A5MS43MFSAA	V
1	0.75	2.7	A	VFD2A7MS43MNSAA	-
		2.7		VFD2A7MS43MFSAA	V
2	1.5	4.2	A	VFD4A2MS43MNSAA	-
		4.2		VFD4A2MS43MFSAA	V
3	2.2	5.5	A	VFD5A5MS43MNSAA	-
		5.5	B	VFD5A5MS43MFSAA	V
5	3.7	9	B	VFD9A0MS43MNSAA	-
		9		VFD9A0MS43MFSAA	V
7.5	5.5	13	C	VFD13AMS43MNSAA	-
		13		VFD13AMS43MFSAA	V
10	7.5	17	C	VFD17AMS43MNSAA	-
		17		VFD17AMS43MFSAA	V

Plate Mount Models (0~599 Hz)

Power Range		Drive Rated Output Current [A]	Frame Size	Model Name	Built-in EMC Filter
Max. Applicable Motor Capacity					
[HP]	[kW]				
460 V / 3-phase					
1	0.75	2.7	A	VFD2A7MS43PNSAA	-
2	1.5	4.2	B	VFD4A2MS43PNSAA	-
3	2.2	5.5	C	VFD5A5MS43PNSAA	-
4	3	7.3		VFD7A3MS43PNSAA	-
5	3.7	9		VFD9A0MS43PNSAA	-



Industrial Automation Headquarters

Taiwan: Delta Electronics, Inc.

Taoyuan Technology Center
No.18, Xinglong Rd., Taoyuan District,
Taoyuan City 330477, Taiwan
TEL: +886-3-362-6301 / FAX: +886-3-371-6301

Asia

China: Delta Electronics (Shanghai) Co., Ltd.

No.182 Minyu Rd., Pudong Shanghai, P.R.C.
Post code : 201209
TEL: +86-21-6872-3988 / FAX: +86-21-6872-3996
Customer Service: 400-820-9595

Japan: Delta Electronics (Japan), Inc.

Industrial Automation Sales Department
2-1-14 Shibadaimon, Minato-ku
Tokyo, Japan 105-0012
TEL: +81-3-5733-1155 / FAX: +81-3-5733-1255

Korea: Delta Electronics (Korea), Inc.

1511, 219, Gasan Digital 1-Ro., Geumcheon-gu,
Seoul, 08501 South Korea
TEL: +82-2-515-5305 / FAX: +82-2-515-5302

Singapore: Delta Energy Systems (Singapore) Pte Ltd.

4 Kaki Bukit Avenue 1, #05-04, Singapore 417939
TEL: +65-6747-5155 / FAX: +65-6744-9228

India: Delta Electronics (India) Pvt. Ltd.

Plot No.43, Sector 35, HSIIDC Gurgaon,
PIN 122001, Haryana, India
TEL: +91-124-4874900 / FAX: +91-124-4874945

Thailand: Delta Electronics (Thailand) PCL.

909 Soi 9, Moo 4, Bangpoo Industrial Estate (E.P.Z),
Pattana 1 Rd., T.Phraksa, A.Muang,
Samutprakarn 10280, Thailand
TEL: +66-2709-2800 / FAX: +66-2709-2827

Australia: Delta Electronics (Australia) Pty Ltd.

Unit 2, Building A, 18-24 Ricketts Road,
Mount Waverley, Victoria 3149 Australia
Mail: IA.au@deltaww.com
TEL: +61-1300-335-823 / +61-3-9543-3720

Americas

USA: Delta Electronics (Americas) Ltd.

5101 Davis Drive, Research Triangle Park, NC 27709, U.S.A.
TEL: +1-919-767-3813

Brazil: Delta Electronics Brazil Ltd.

Estrada Velha Rio-São Paulo, 5300 Eugênio de
Melo - São José dos Campos CEP: 12247-004 - SP - Brazil
TEL: +55-12-3932-2300 / FAX: +55-12-3932-237

Mexico: Delta Electronics International Mexico S.A. de C.V.

Gustavo Baz No. 309 Edificio E PB 103
Colonia La Loma, CP 54060
Tlalnepantla, Estado de México
TEL: +52-55-3603-9200

EMEA

EMEA Headquarters: Delta Electronics (Netherlands) B.V.

Sales: Sales.IA.EMEA@deltaww.com
Marketing: Marketing.IA.EMEA@deltaww.com
Technical Support: iatechnicalsupport@deltaww.com
Customer Support: Customer-Support@deltaww.com
Service: Service.IA.emea@deltaww.com
TEL: +31(0)40 800 3900

BENELUX: Delta Electronics (Netherlands) B.V.

Automotive Campus 260, 5708 JZ Helmond, The Netherlands
Mail: Sales.IA.Benelux@deltaww.com
TEL: +31(0)40 800 3900

DACH: Delta Electronics (Netherlands) B.V.

Coesterweg 45, D-59494 Soest, Germany
Mail: Sales.IA.DACH@deltaww.com
TEL: +49 2921 987 238

France: Delta Electronics (France) S.A.

ZI du bois Challand 2, 15 rue des Pyrénées,
Lisses, 91090 Evry Cedex, France
Mail: Sales.IA.FR@deltaww.com
TEL: +33(0)1 69 77 82 60

Iberia: Delta Electronics Solutions (Spain) S.L.U

Ctra. De Villaverde a Vallecas, 265 1º Dcha Ed.
Hormigueras – P.I. de Vallecas 28031 Madrid
TEL: +34(0)91 223 74 20

Carrer Llacuna 166, 08018 Barcelona, Spain
Mail: Sales.IA.Iberia@deltaww.com

Italy: Delta Electronics (Italy) S.r.l.

Via Meda 2-22060 Novedrate(CO)
Piazza Grazioli 18 00186 Roma Italy
Mail: Sales.IA.Italy@deltaww.com
TEL: +39 039 8900365

Turkey: Delta Greentech Elektronik San. Ltd. Sti. (Turkey)

Şerifali Mah. Hendem Cad. Kule Sok. No:16-A
34775 Ümraniye – İstanbul
Mail: Sales.IA.Turkey@deltaww.com
TEL: + 90 216 499 9910

MEA: Eltek Dubai (Eltek MEA DMCC)

OFFICE 2504, 25th Floor, Saba Tower 1,
Jumeirah Lakes Towers, Dubai, UAE
Mail: Sales.IA.MEA@deltaww.com
TEL: +971(0)4 2690148

*We reserve the right to change the information in this catalogue without prior notice.

DELTA_IA-MDS_MS300_C_EN_20241104